



RTUELS

GÉOMÉTRIE CP

Ecole élémentaire Saint Exupéry Vénissieux

SOMMAIRE



Se repérer sur un quadrillage

Se déplacer sur un quadrillage

Se situer dans l'espace

Tracer à la règle + Annexes

Reconnaître des figures géométriques

Reconnaître des solides





Reproduire des algorithmes + Annexes







Se repérer sur





un quadrillage

1. Sur ton ardoise, indique les coordonnées de chaque forme.

	1	2	3	4	5
A					
B					
C					
D					
E					

				
- ; -	- ; -	- ; -	- ; -	- ; -

Correction

	1	2	3	4	5
A					
B					
C					
D					
E					

				
<u>C</u>; <u>5</u>	<u>A</u>; <u>1</u>	<u>D</u>; <u>2</u>	<u>E</u>; <u>4</u>	<u>B</u>; <u>3</u>

2. Sur ton ardoise, indique les coordonnées de chaque forme.

	1	2	3	4	5
A			⊖		
B		☀			
C	🦷				
D				🐰	
E					☁





⊖	🦷	🐰	☁	☀
_ ; _	_ ; _	_ ; _	_ ; _	_ ; _





Correction

	1	2	3	4	5
A			⊖		
B		☀			
C	🦷				
D				🐰	
E					☁

⊖	🦷	🐰	☁	☀
<u>A</u> ; <u>3</u>	<u>C</u> ; <u>1</u>	<u>D</u> ; <u>4</u>	<u>E</u> ; <u>5</u>	<u>B</u> ; <u>2</u>

3. Sur ton ardoise, indique les coordonnées de chaque forme.

	1	2	3	4	5
A				✓	
B					
C					
D					
E					

				
- ; -	- ; -	- ; -	- ; -	- ; -

Correction

	1	2	3	4	5
A				✓	
B	🌸				
C			🏠		
D					⊘
E		🔍			

✓	🌸	🔍	⊘	🏠
A; 4	B; 1	E; 2	D; 5	C; 3

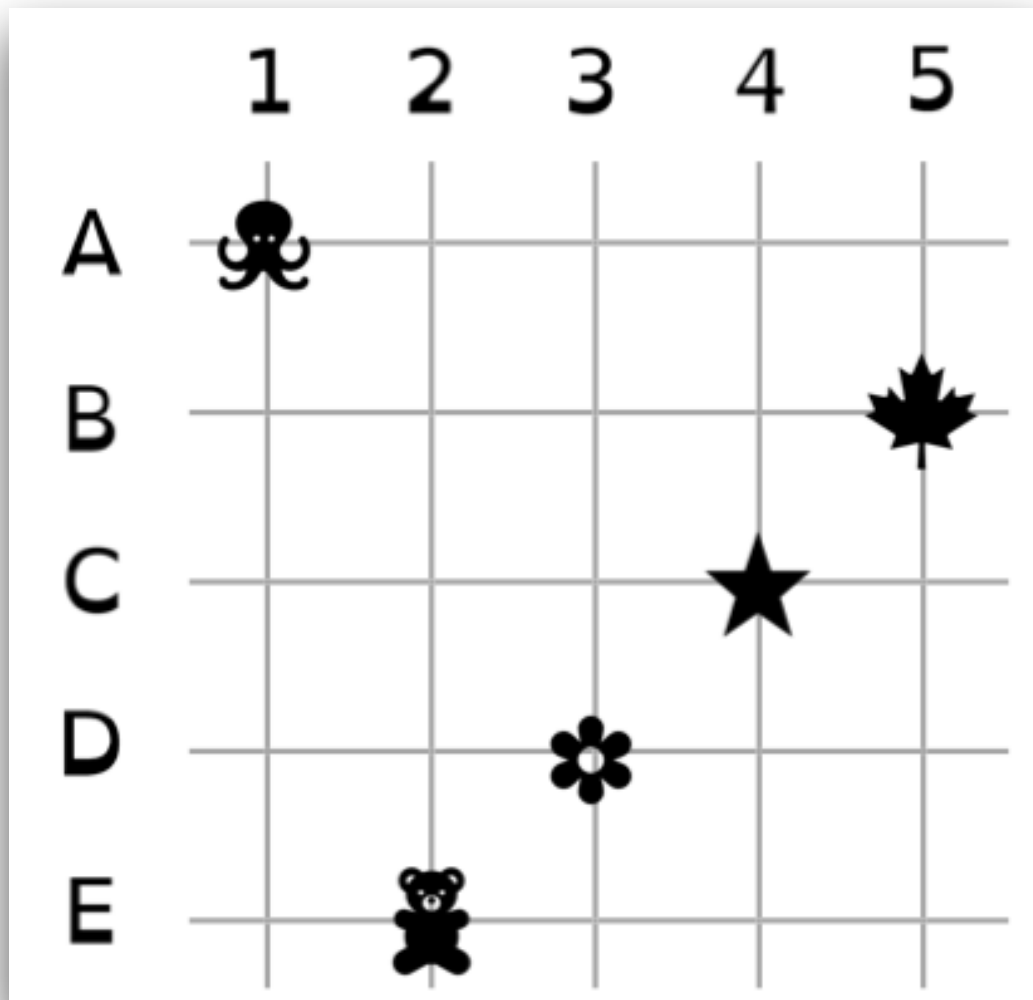

4. Sur ton ardoise, indique les coordonnées de chaque forme.



				
- ; -	- ; -	- ; -	- ; -	- ; -

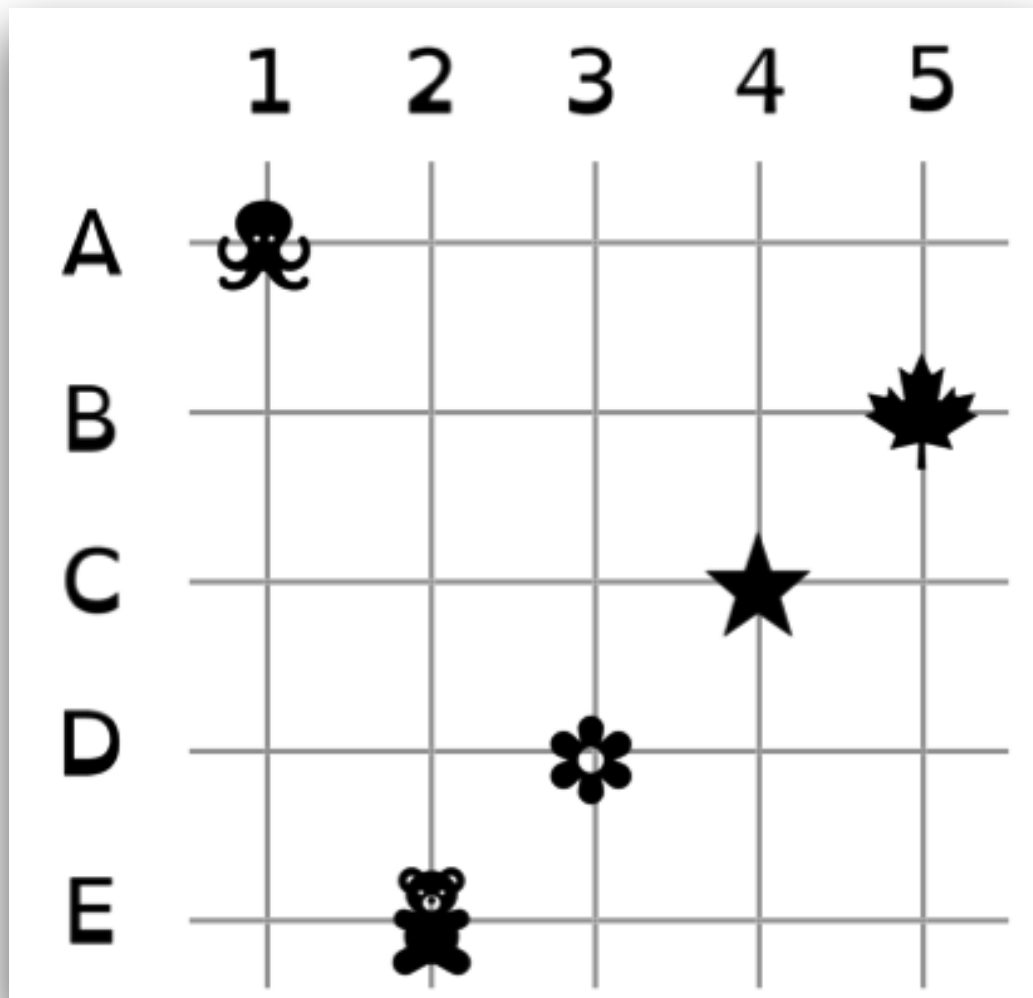



Correction

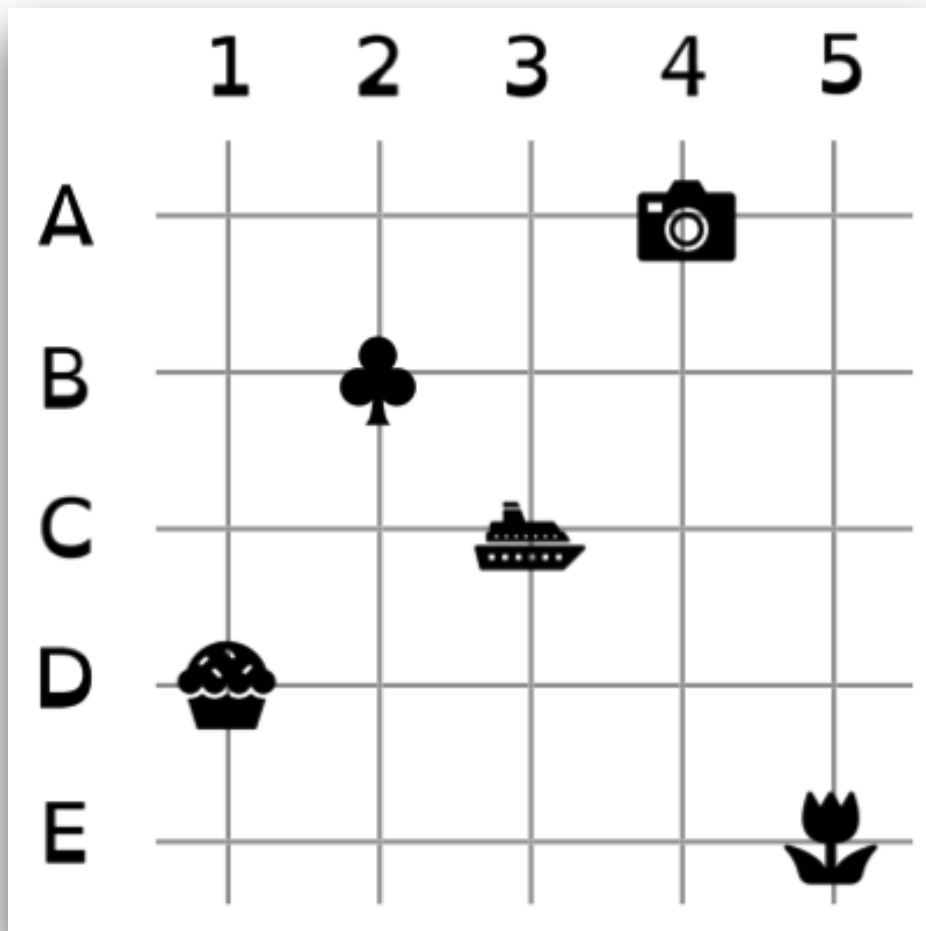

				
<u>D</u>; <u>3</u>	<u>B</u>; <u>5</u>	<u>A</u>; <u>1</u>	<u>E</u>; <u>2</u>	<u>C</u>; <u>4</u>

5. Sur ton ardoise, indique les coordonnées de chaque forme.



				
- ; -	- ; -	- ; -	- ; -	- ; -

Correction

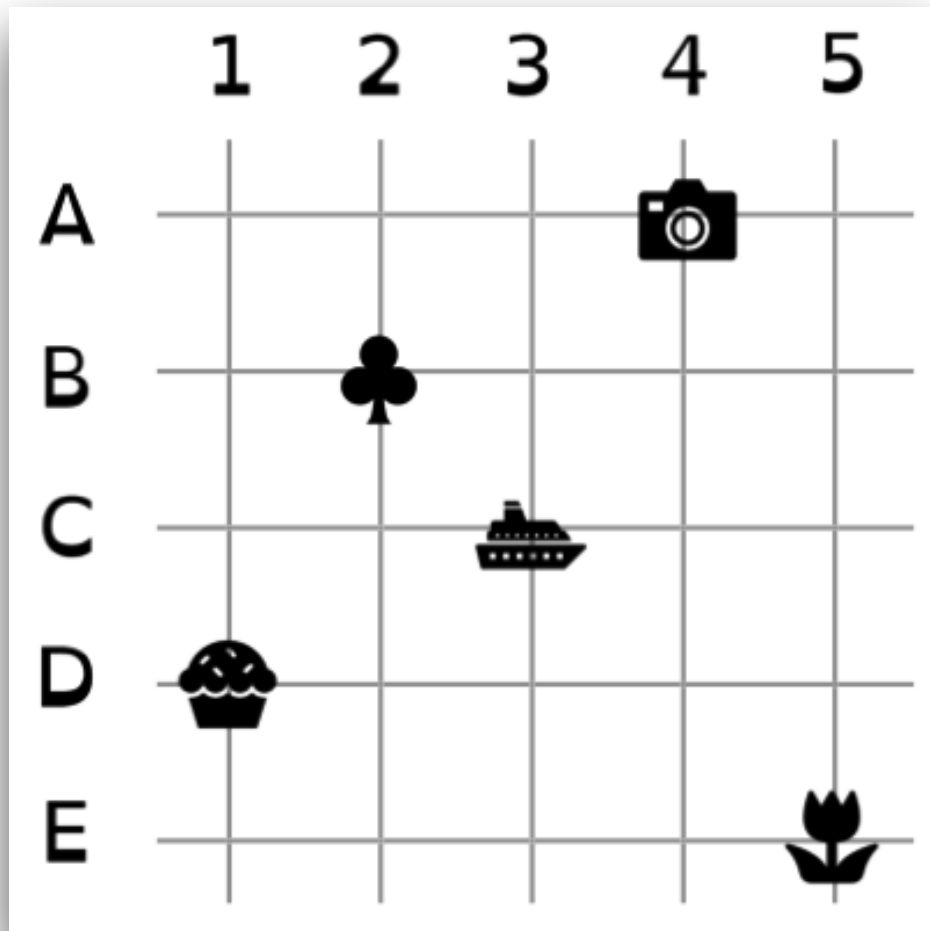

				
A; 4	B; 2	C; 3	D; 1	E; 5

6. Sur ton ardoise, indique les coordonnées de chaque forme.

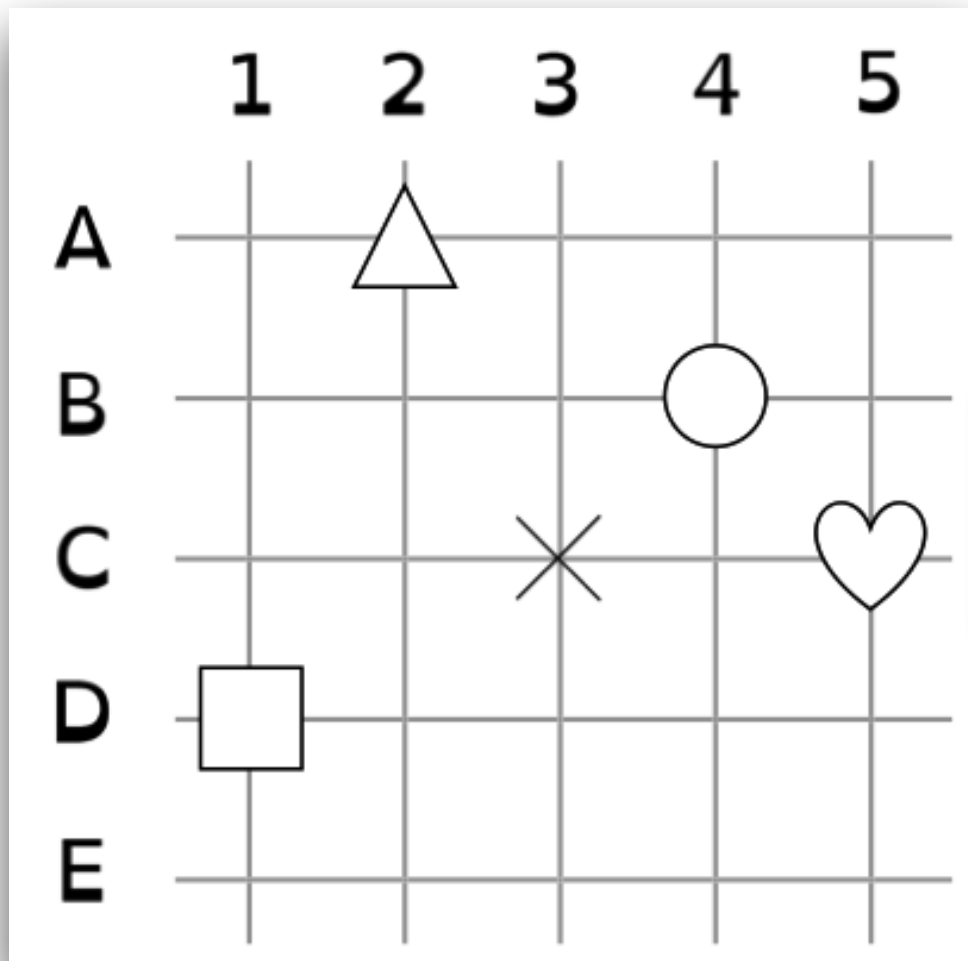

○	□	△	♥	×
- ; -	- ; -	- ; -	- ; -	- ; -

Correction

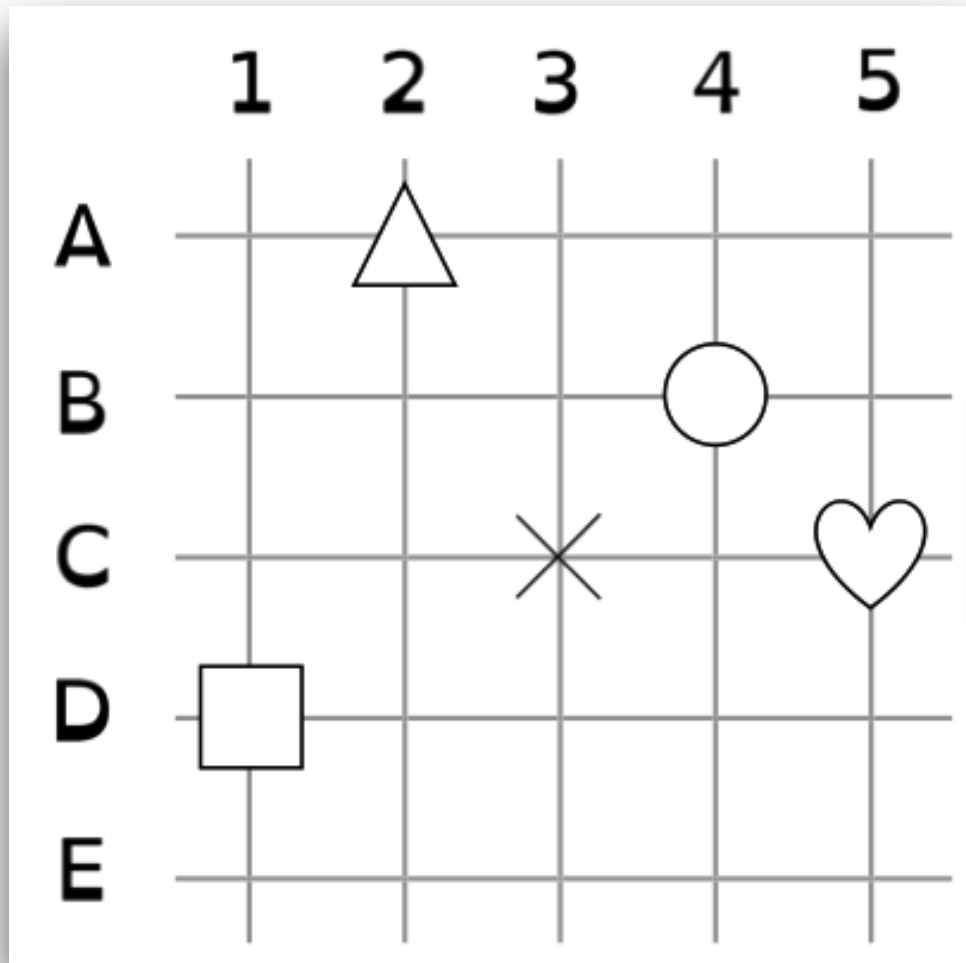

○	□	△	♥	×
<u>B</u> ; <u>4</u>	<u>D</u> ; <u>1</u>	<u>A</u> ; <u>2</u>	<u>C</u> ; <u>5</u>	<u>C</u> ; <u>3</u>

7. Retrouve le mot caché.

Relève dans l'ordre
les lettres situées
dans les cases :

B2 - A3 - C1 - D3 - C4

	1	2	3	4
A	G	E	R	I
B	M	B	T	M
C	A	U	W	O
D	N	K	V	X

Correction

Le mot est :

BRAVO

	1	2	3	4
A	G	E	R	I
B	M	B	T	M
C	A	U	W	O
D	N	K	V	X



Se déplacer sur
un quadrillage

1. Sur ton ardoise, code le chemin du chien.

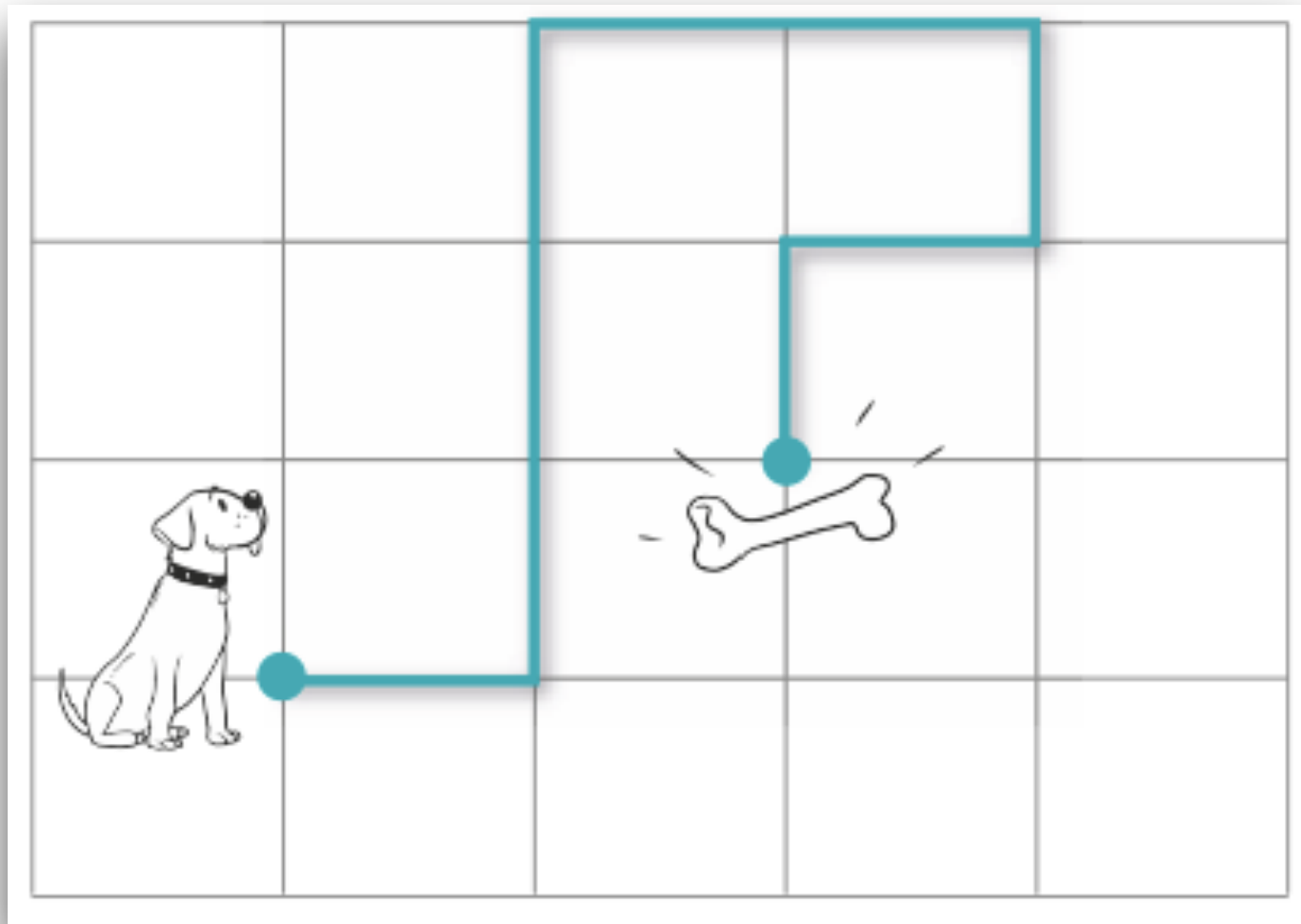

Correction

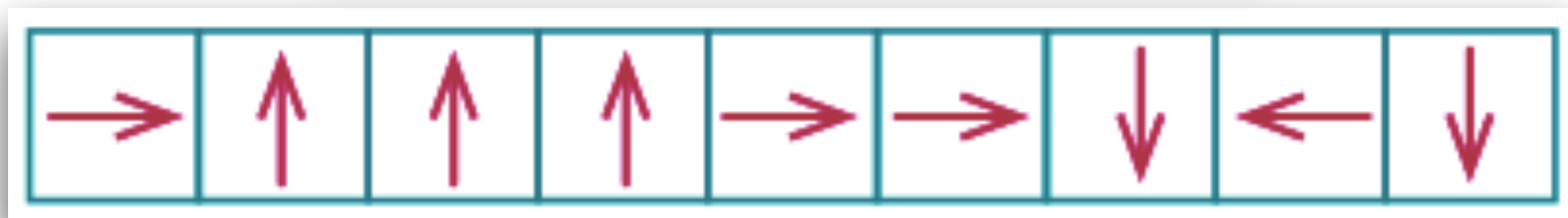
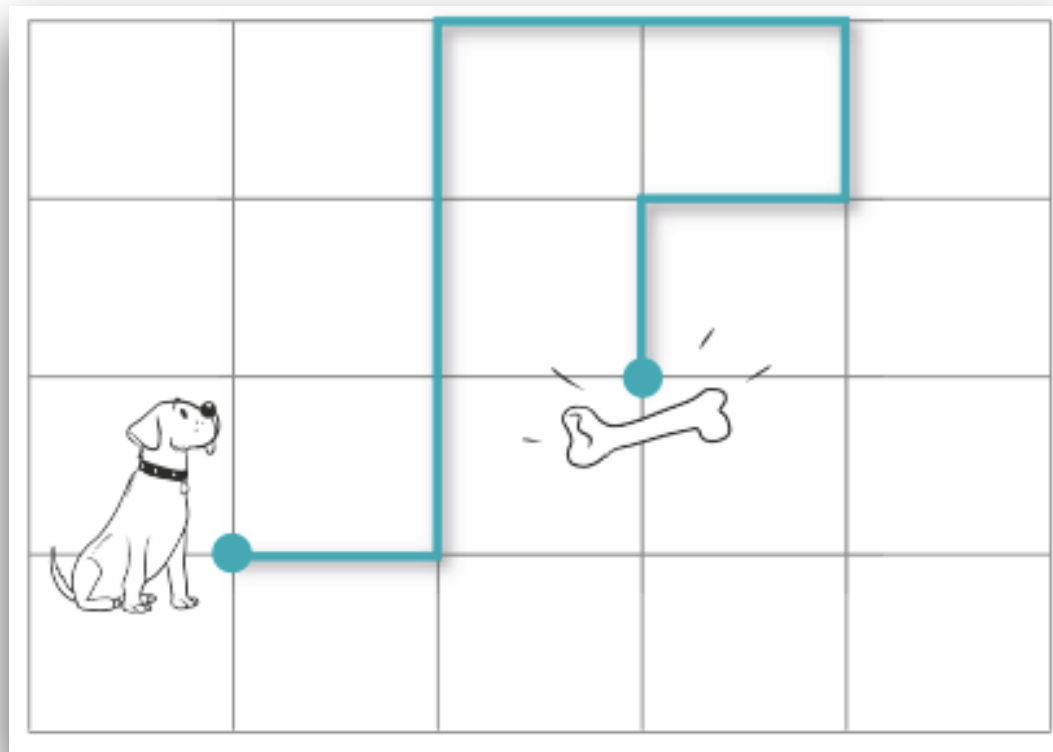

2. Sur ton ardoise, code le chemin du chat.

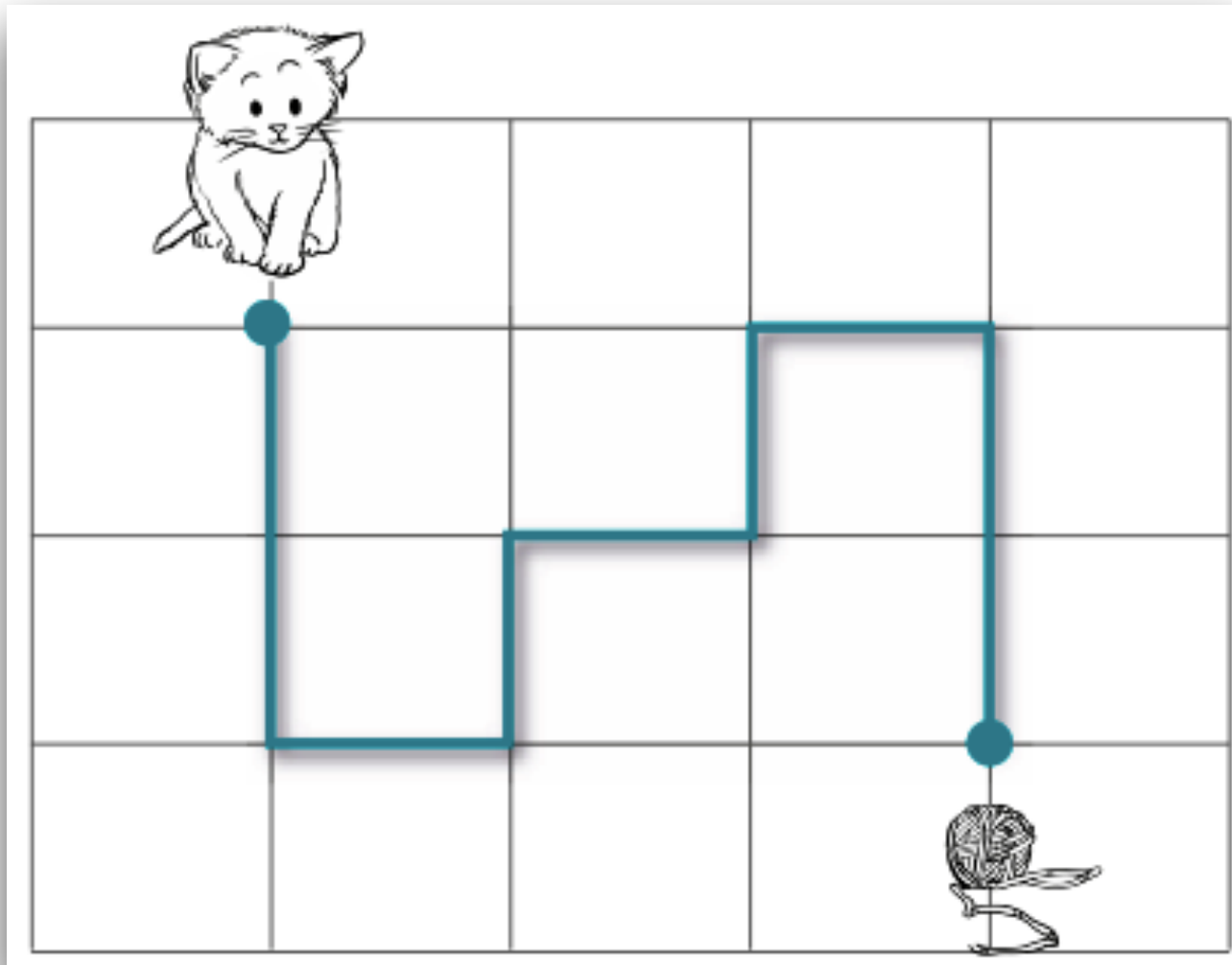

Correction

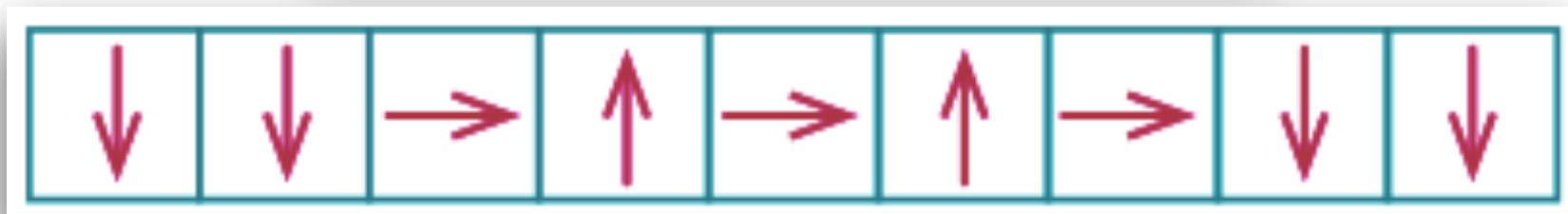
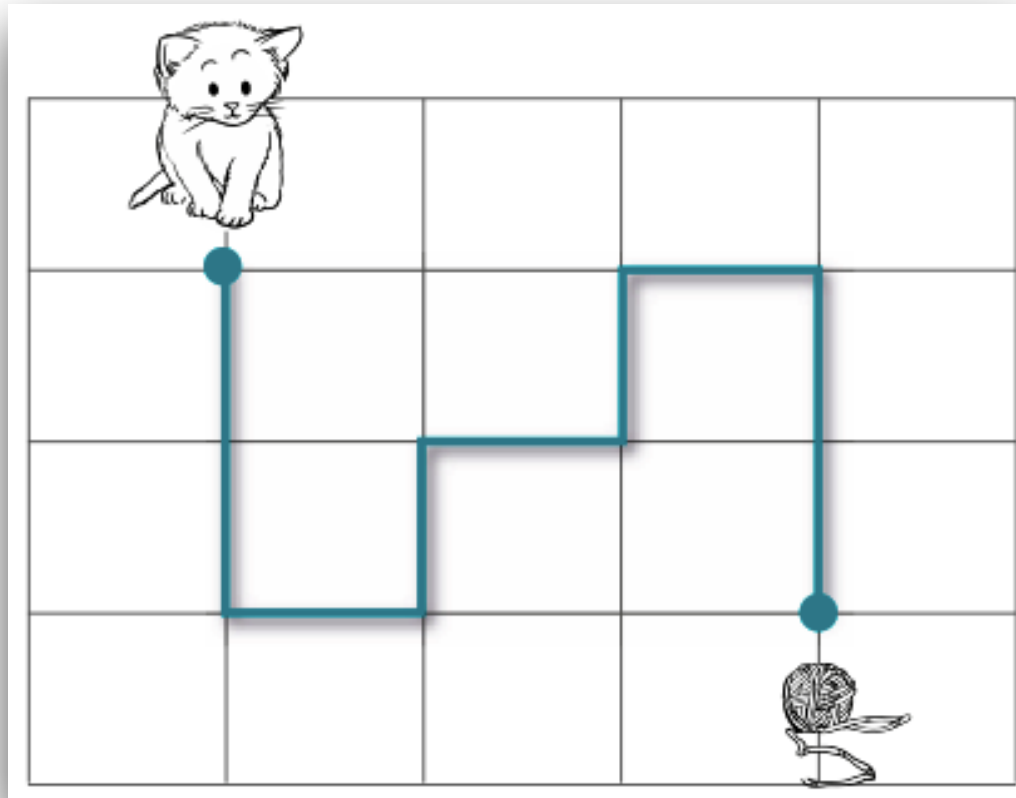

3. Suis le chemin :

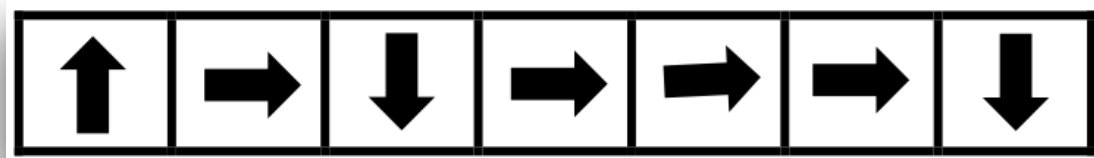

Sur quelle case
va tomber le petit
chaperon rouge ?

	A	B	C	D	E
1					
2					
3					
4					
5					

Correction

E5

	A	B	C	D	E
1					
2					
3	↑	→			
4		↓	→	→	→
5					↓



Se situer dans l'espace

1. Écris sur ton ardoise qui est sous la table : le panier ou le chat ?

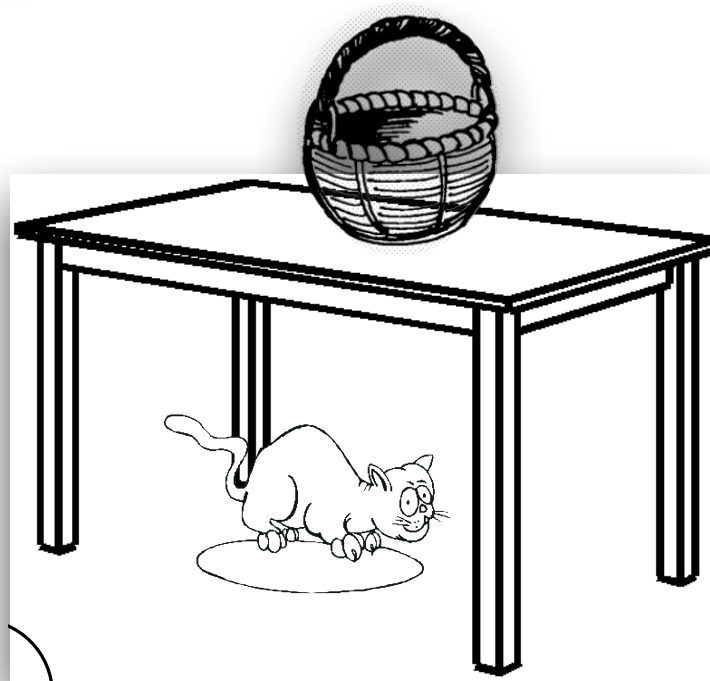

Correction : le chat est sous la table.

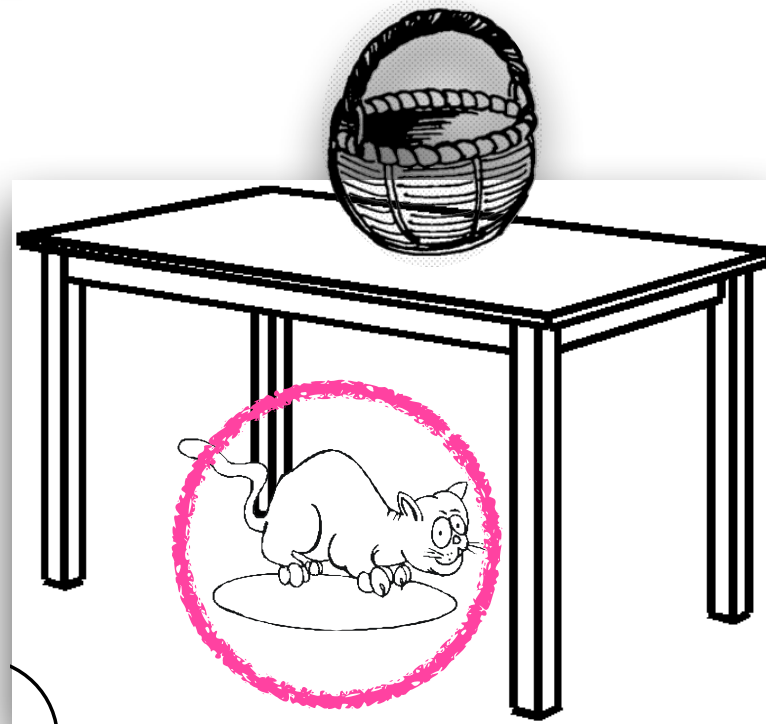

2. Écris sur ton ardoise qui est sur le
cadeau : le papillon ou l'araignée ?

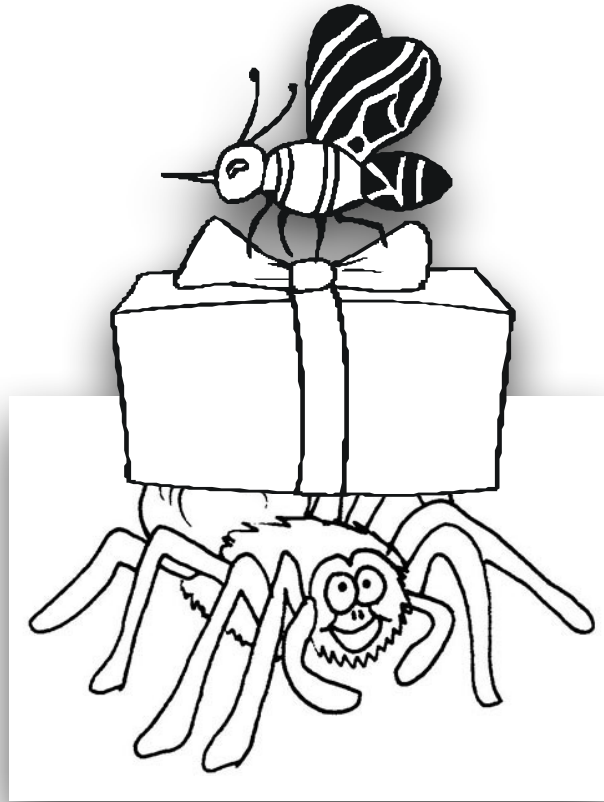

Correction : le papillon est sur le cadeau.

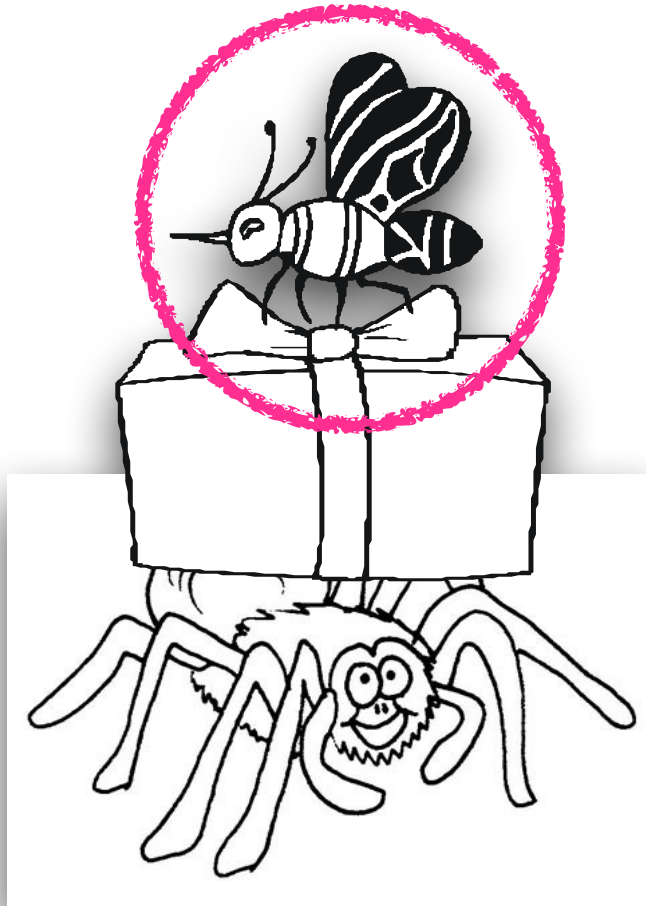

3. Écris sur ton ardoise : qui est devant
Lola ?

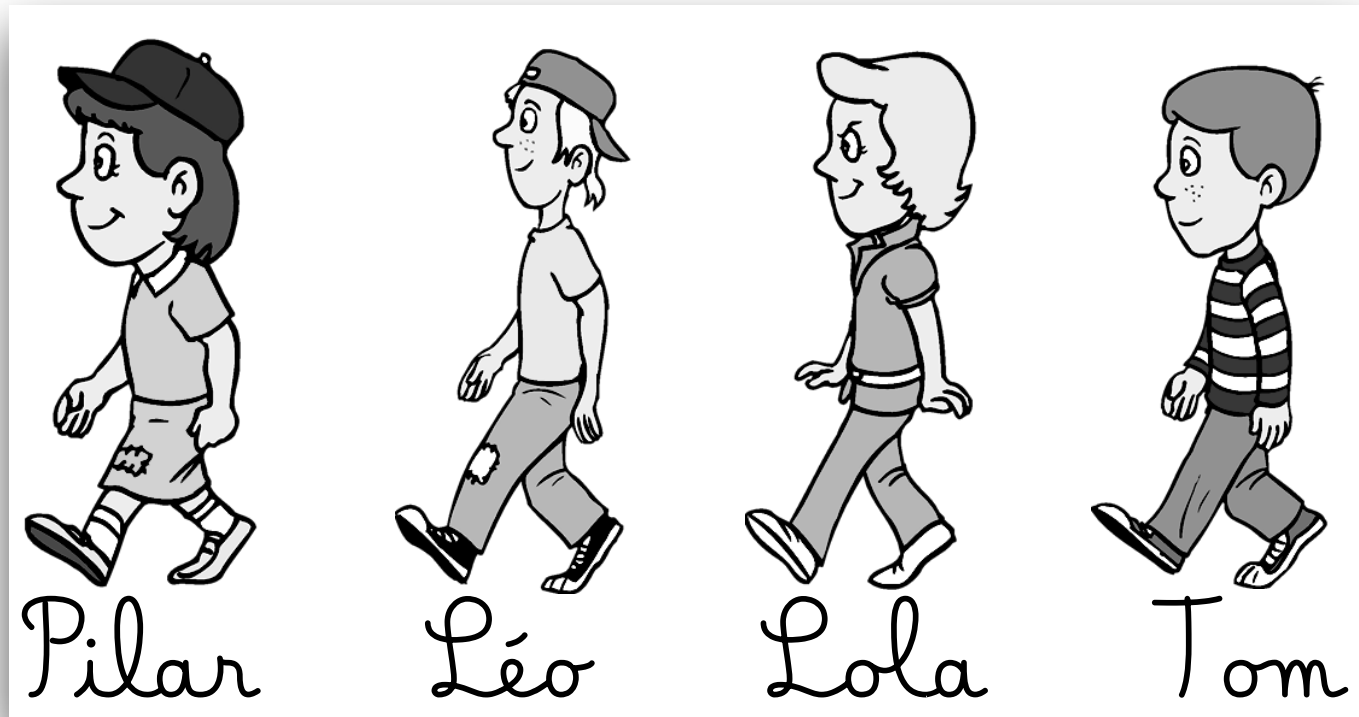

Correction : Léo est devant Lola.

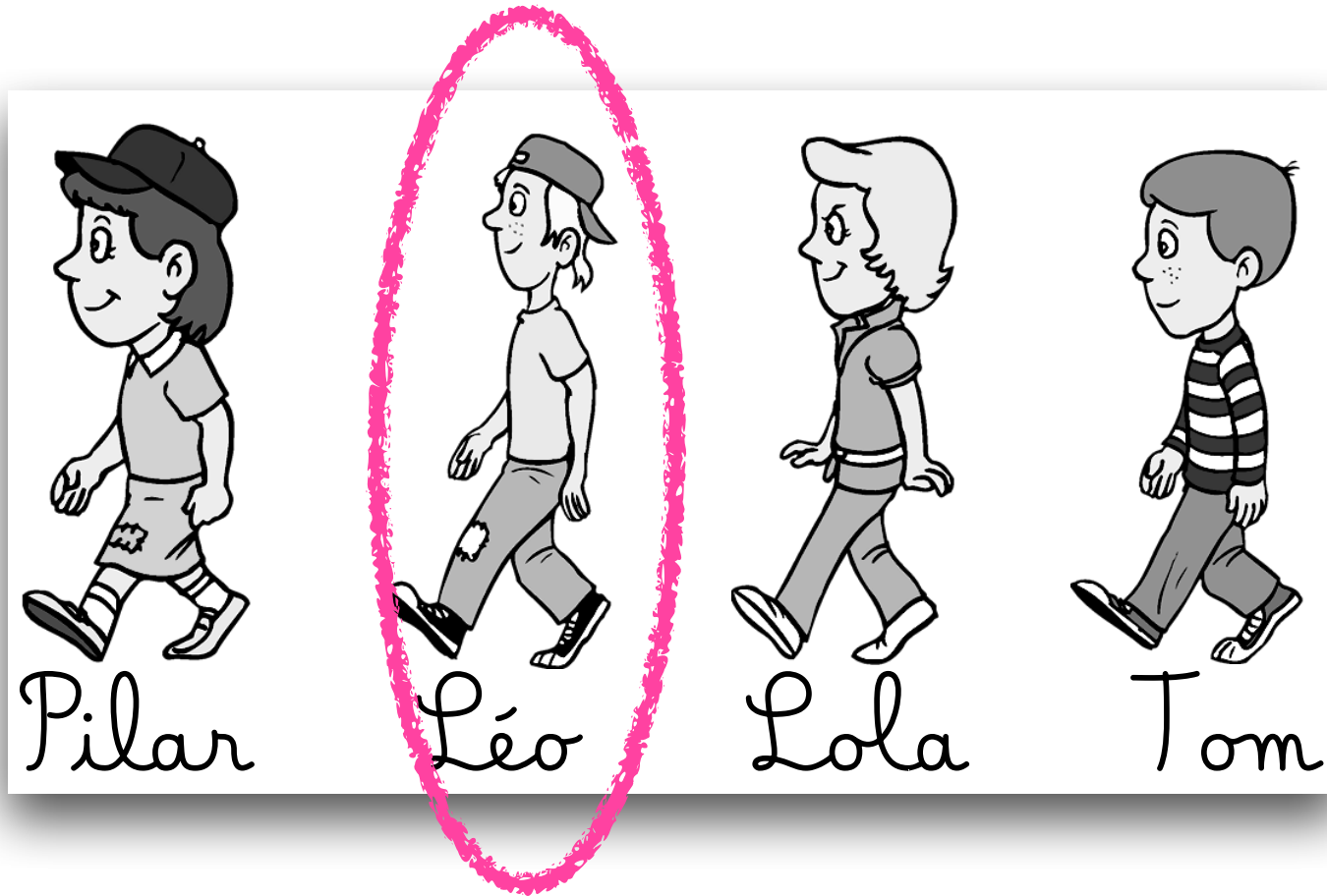

4. Écris sur ton ardoise : qui est derrière
Lola ?

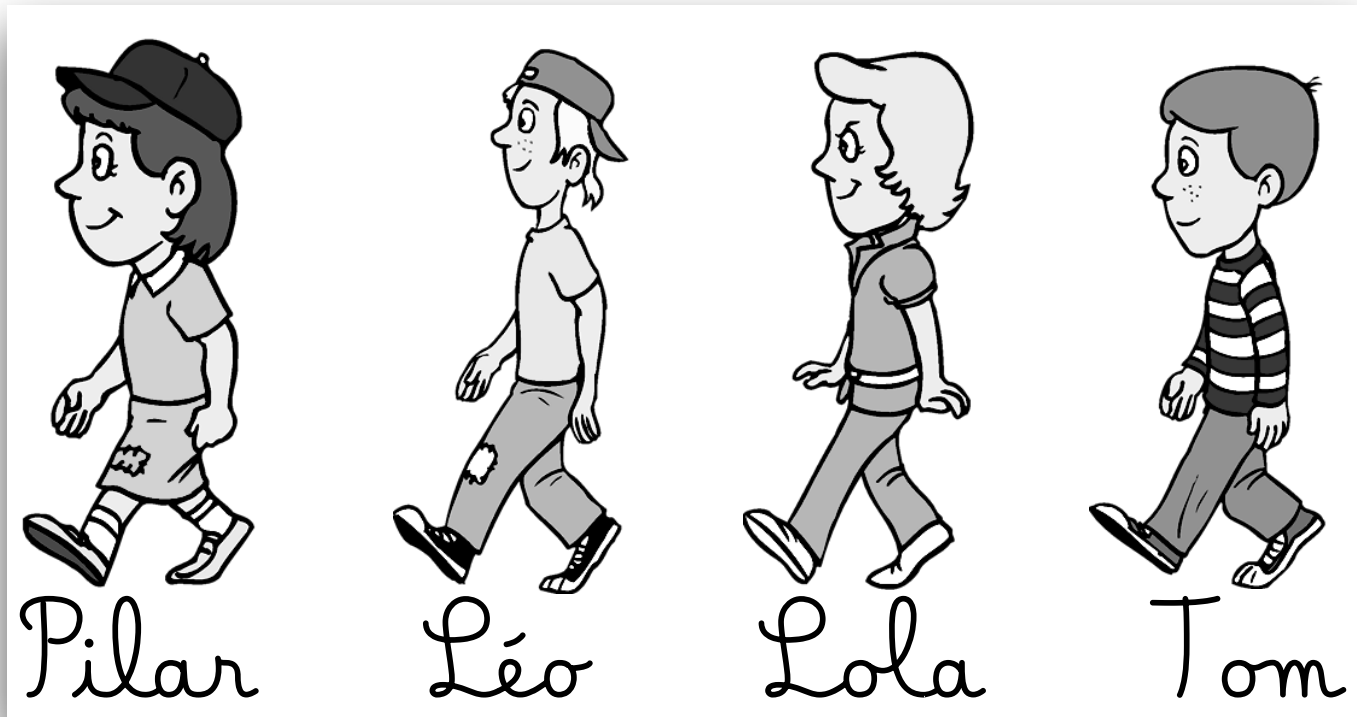

Correction : Tom est derrière Lola.

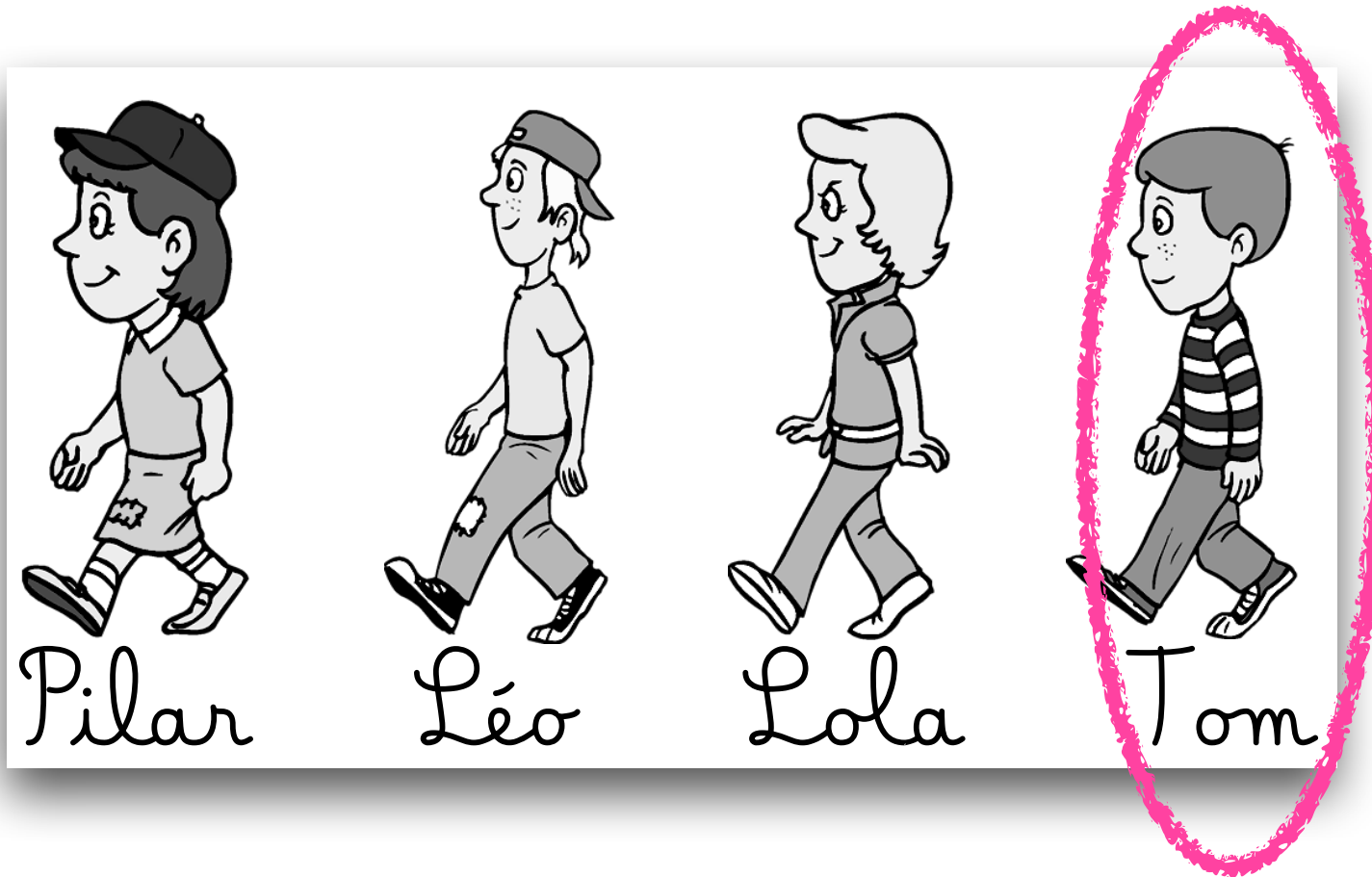

5. Écris sur ton ardoise : qui est entre la chaise et le lit?

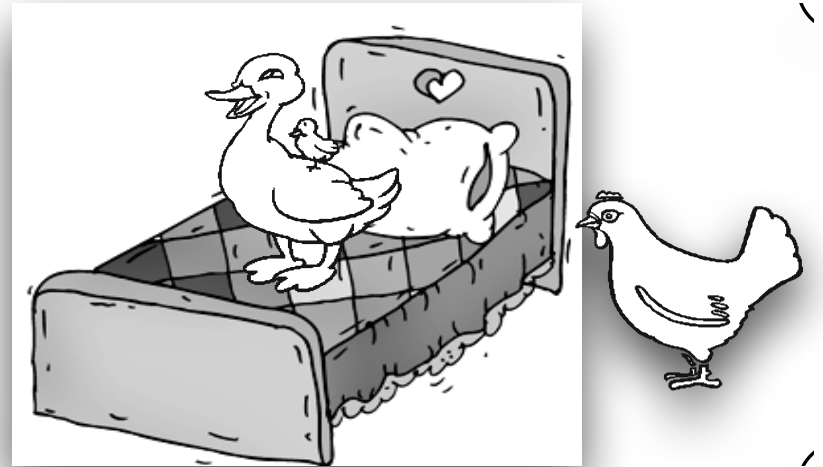
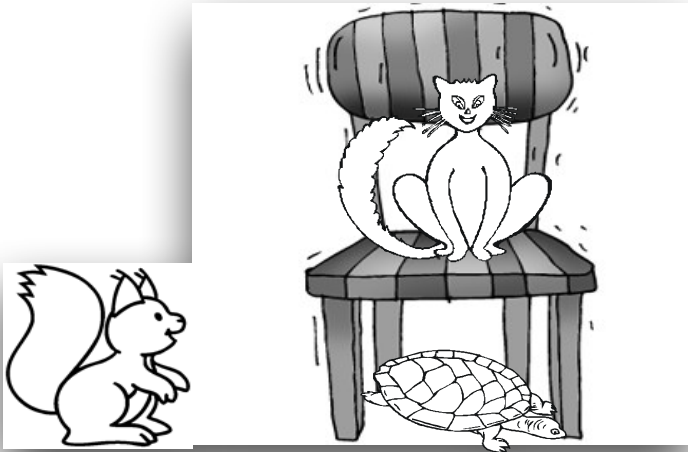

l'écureuil, le chat, la tortue, le chien, le canard, la poule.

Correction : le chien est entre la chaise et le lit.

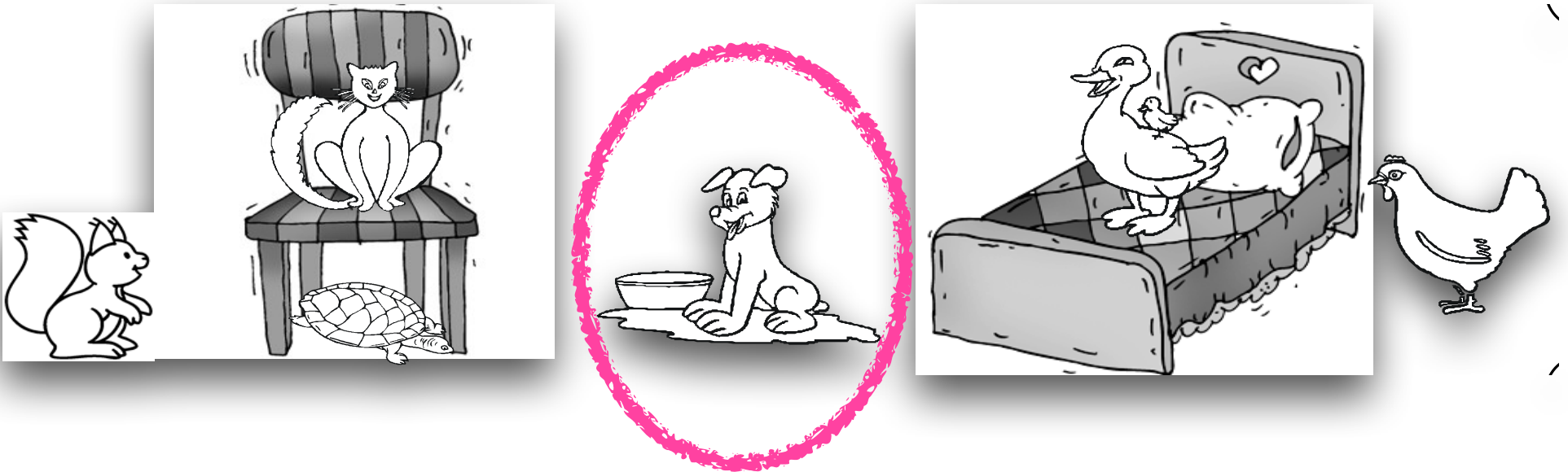

l'écureuil, le chat, la tortue, le chien, le canard, la poule.

6. Écris sur ton ardoise : qui est à droite
du chat ?



la souris

le coq

le chat

le chien

Correction : le chien est à droite du chat.



la souris

le coq

le chat

le chien

7. Ecris sur ton ardoise : qui est à gauche du coq ?



la souris

le coq

le chat

le chien

Correction : la souris est à gauche du coq.



la souris

le coq

le chat

le chien

8. Écris sur ton ardoise : qui est devant?

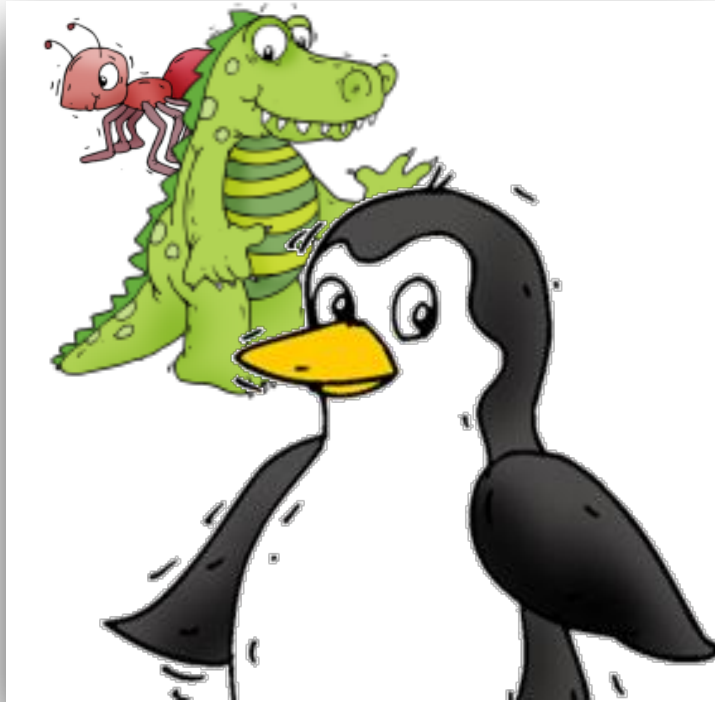

Le pingouin, la fourmi, le crocodile.

Correction : le pingouin est devant.

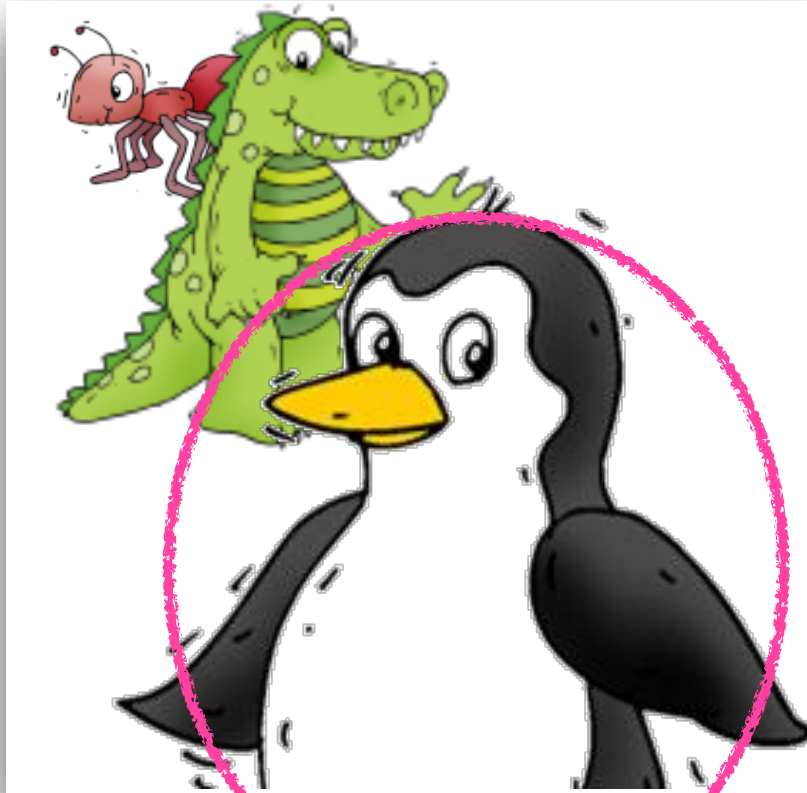

Le pingouin, la fourmi, le crocodile.

9. Écris sur ton ardoise : qui est derrière?



la coccinelle, le panda, la girafe

Correction : la girafe est derrière.



la coccinelle, le panda, la girafe

10. Sur ton ardoise, écris une phrase pour indiquer où se trouve le crocodile.



Le phoque, la coccinelle, le crocodile, la girafe, le panda.

Correction : le crocodile est entre le phoque et la girafe.

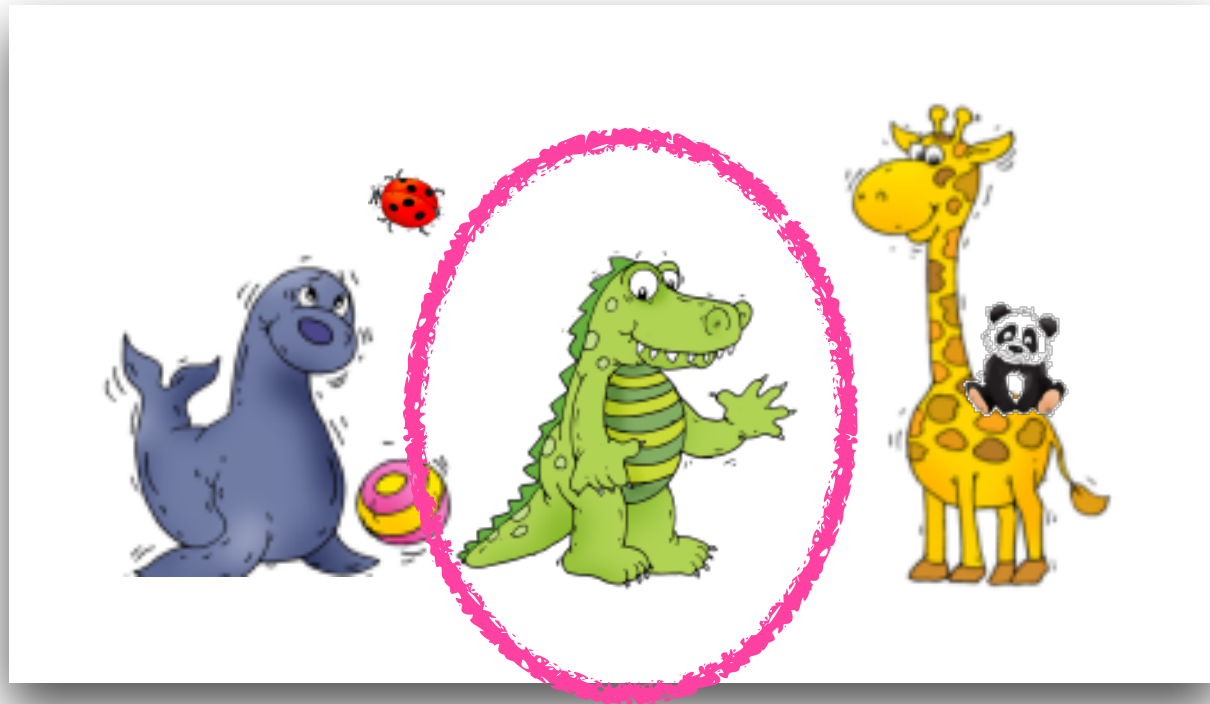

Le phoque, la coccinelle, le crocodile, la girafe, le panda.

11. Sur ton ardoise, écris une phrase pour indiquer où se trouve le panda.



Le phoque, la coccinelle, le crocodile, la girafe, le panda.

Correction : le panda est sur la girafe.

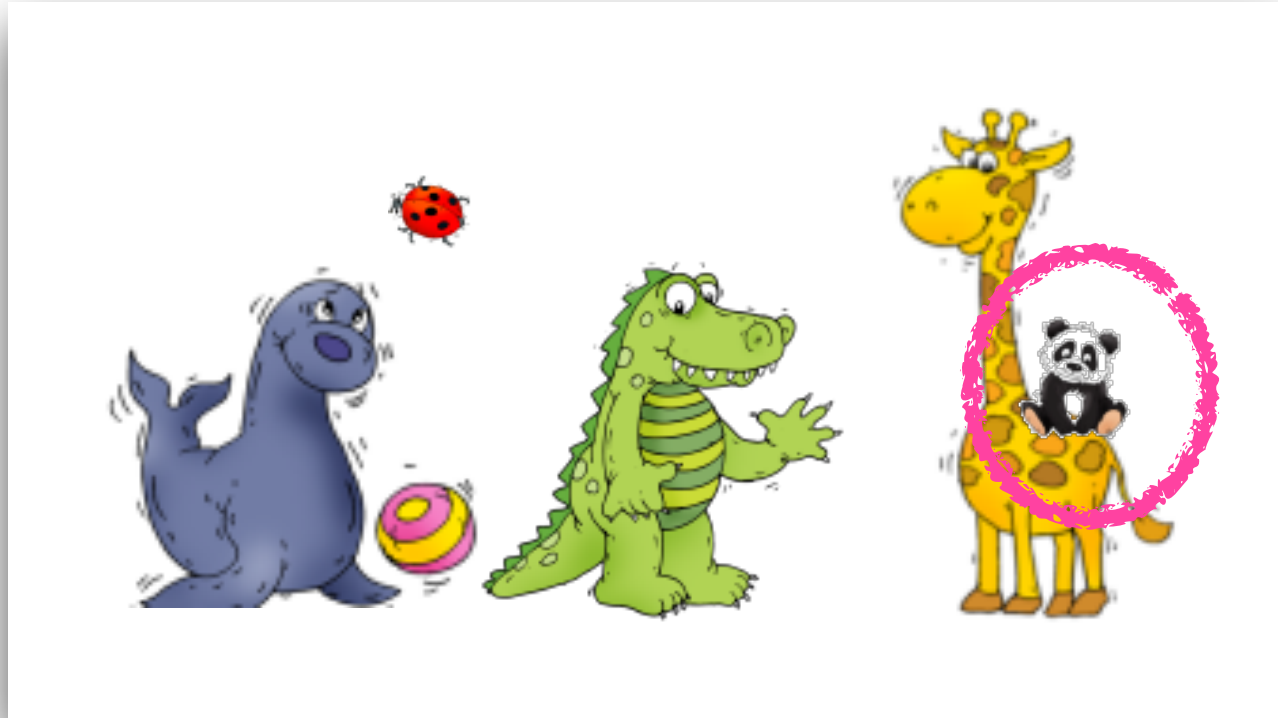

Le phoque, la coccinelle, le crocodile, la girafe, le panda.



1. Repasse sur les pointillés (voir annexes)

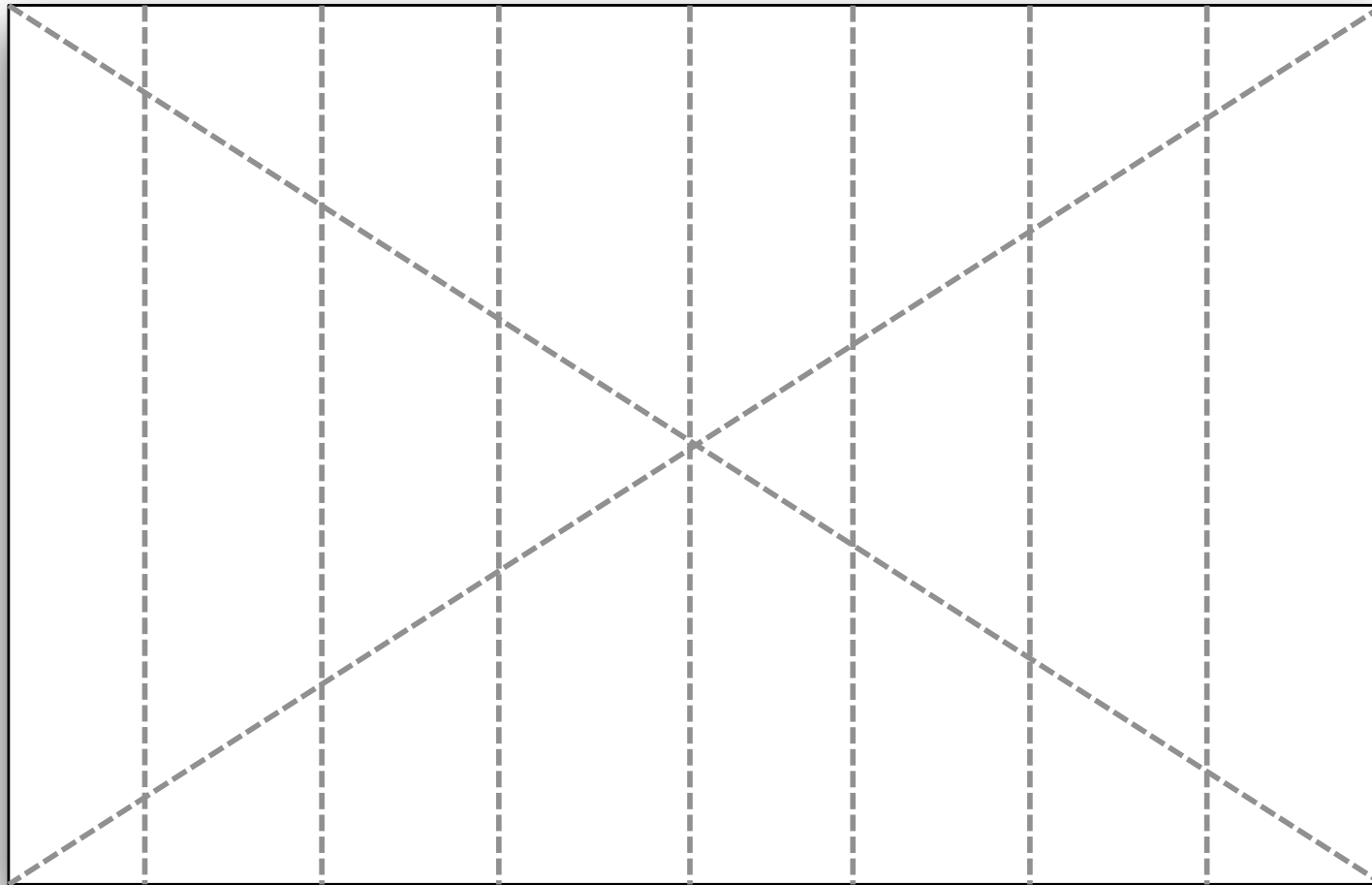

Correction

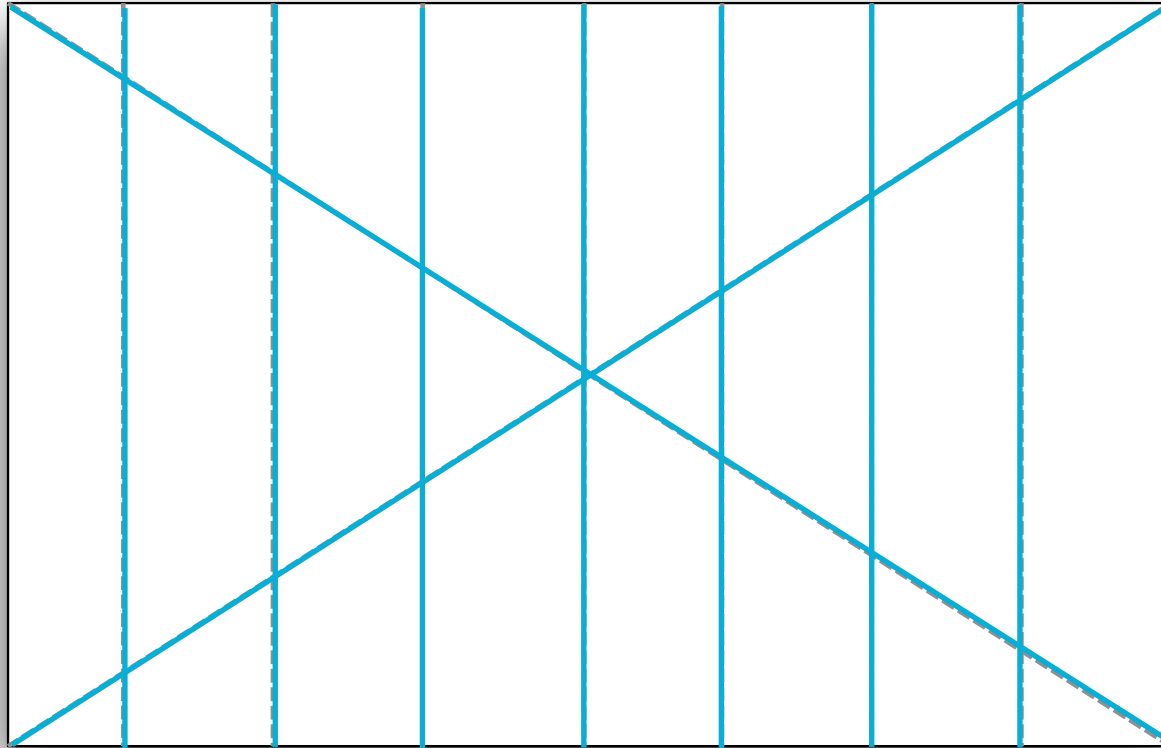

2. Sur ta feuille, trace les barreaux.

(voir annexes)

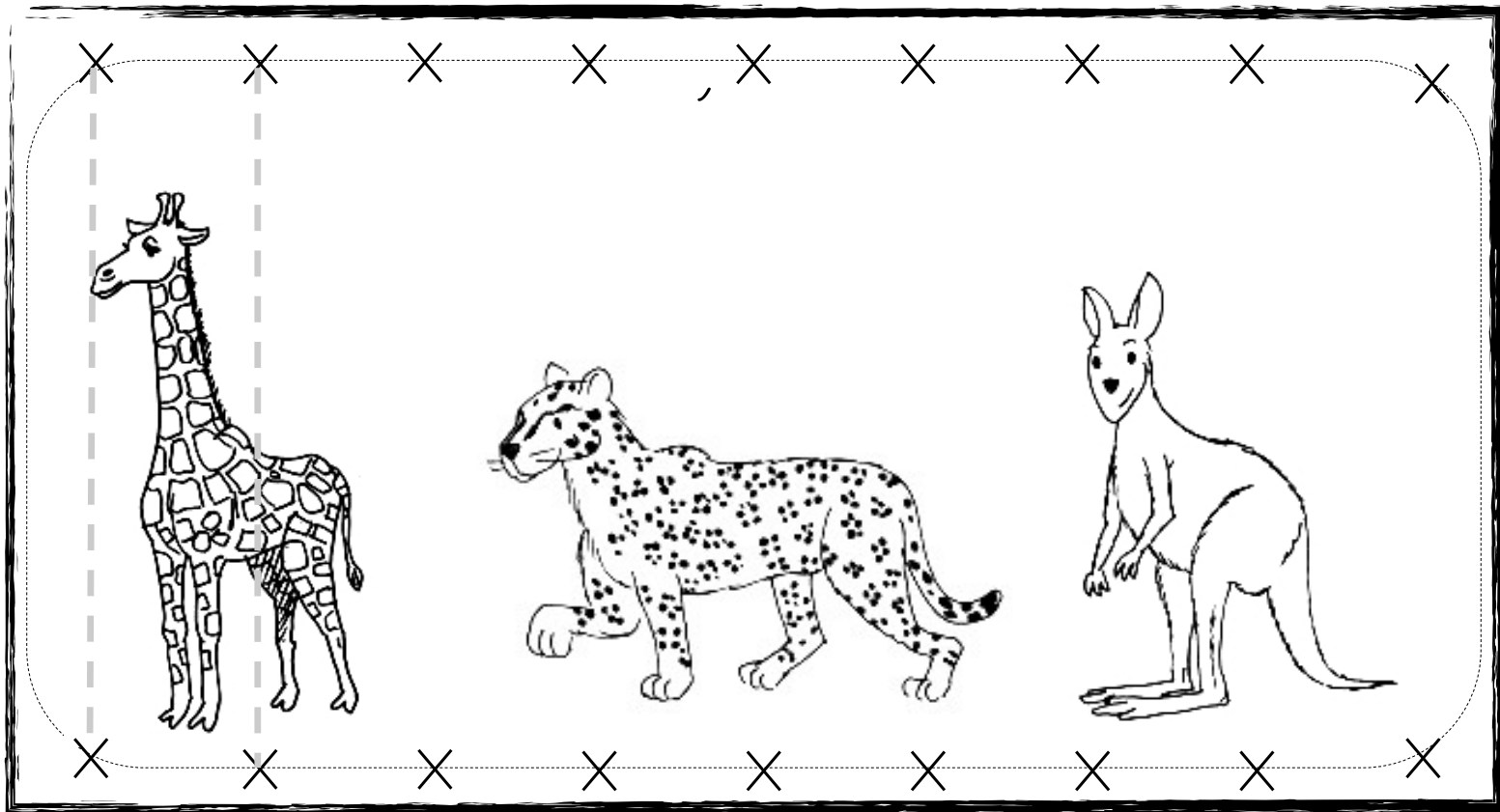

Correction

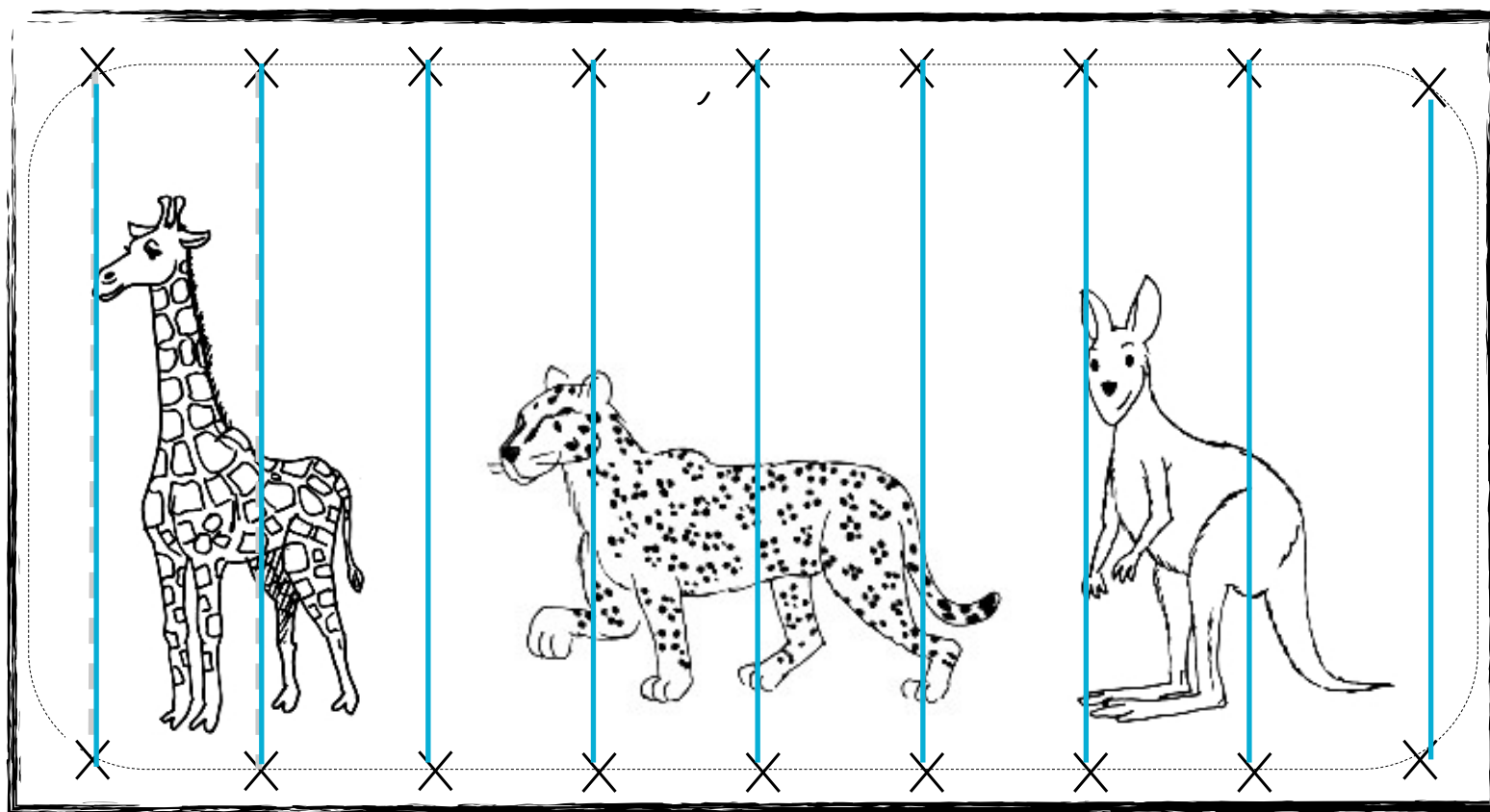

3. Avec ta règle, complète le trajet de chaque flèche. (voir annexes)

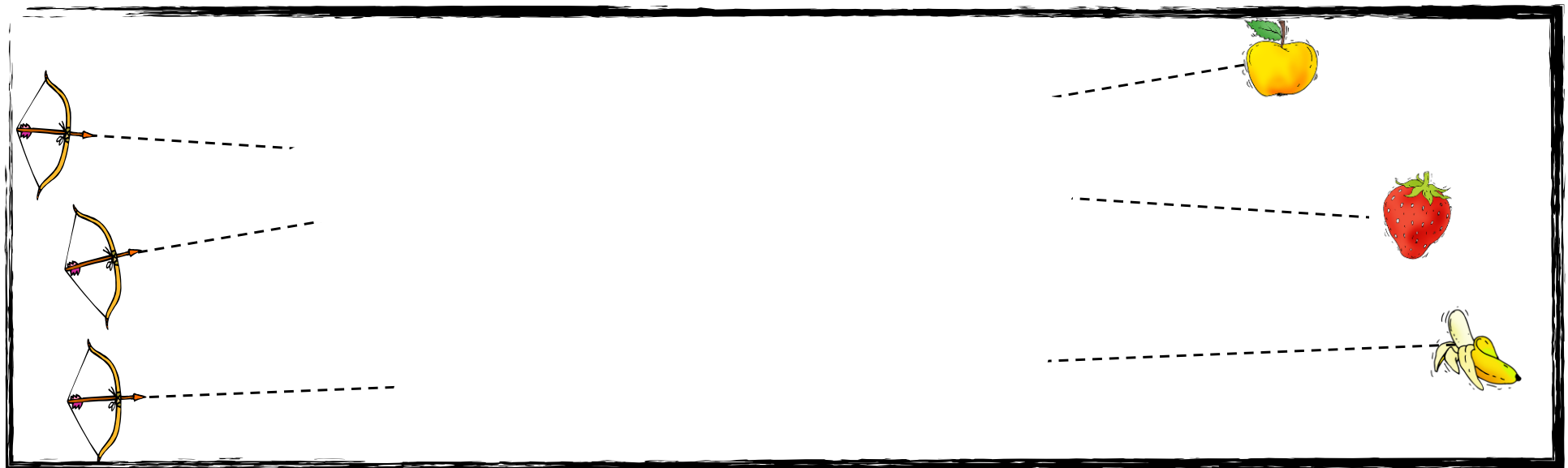

Correction

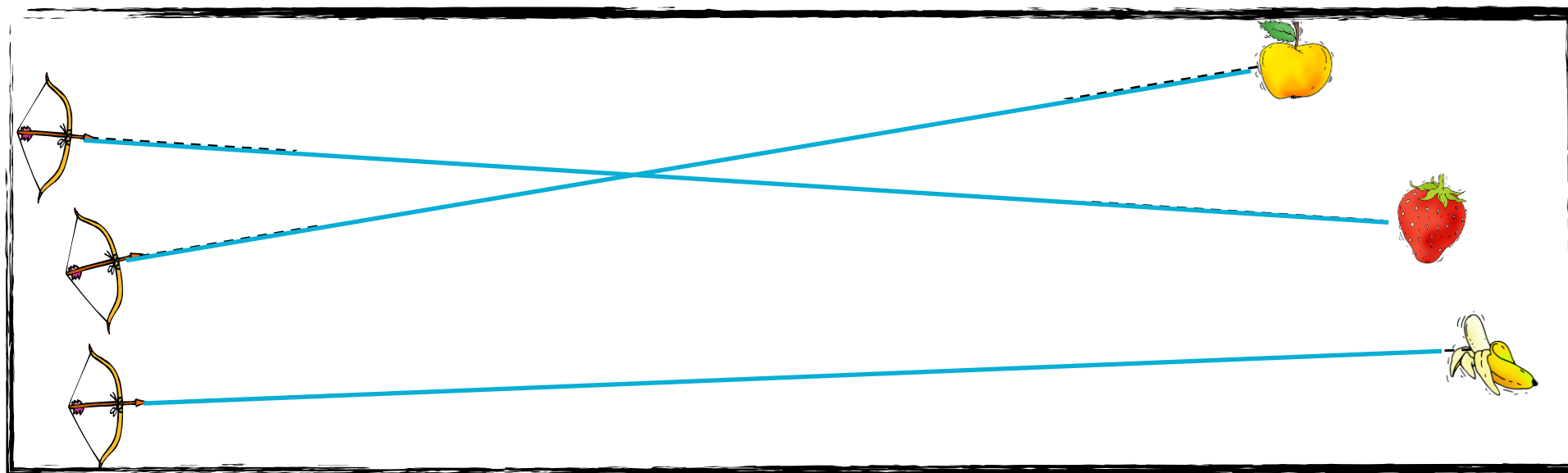

4. Avec ta règle, complète les fils du parachute. (voir annexes)

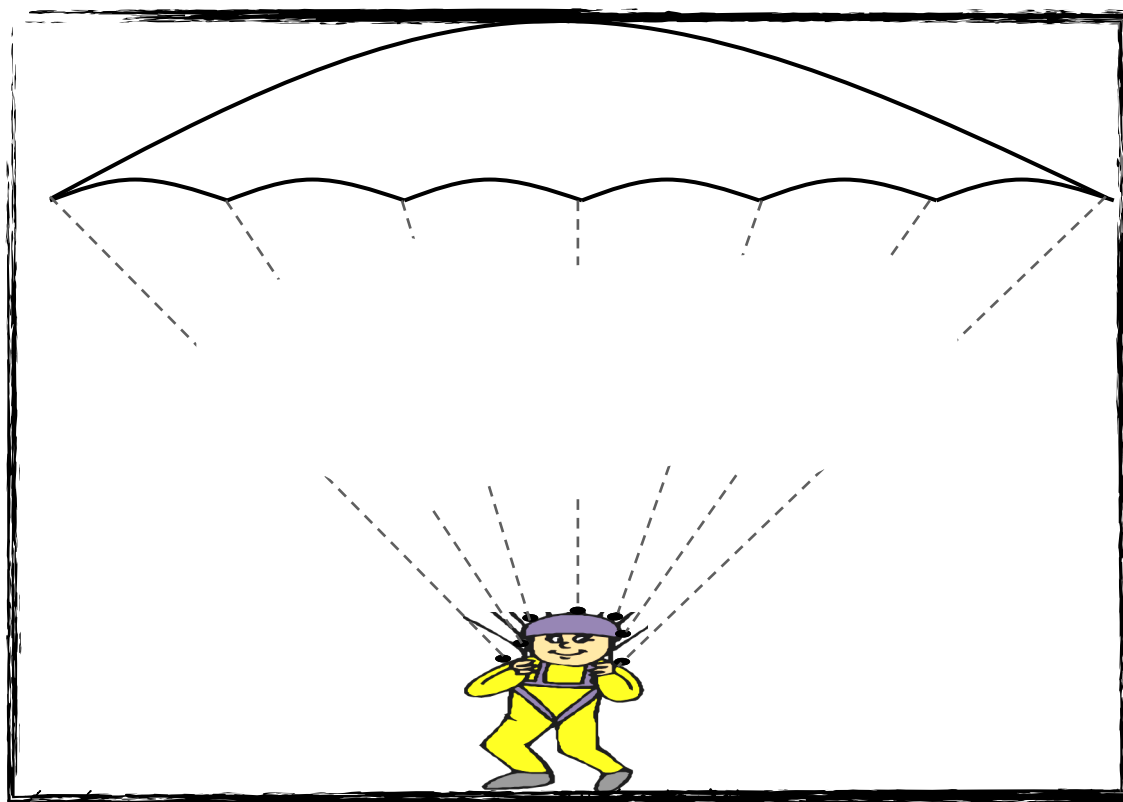

Correction

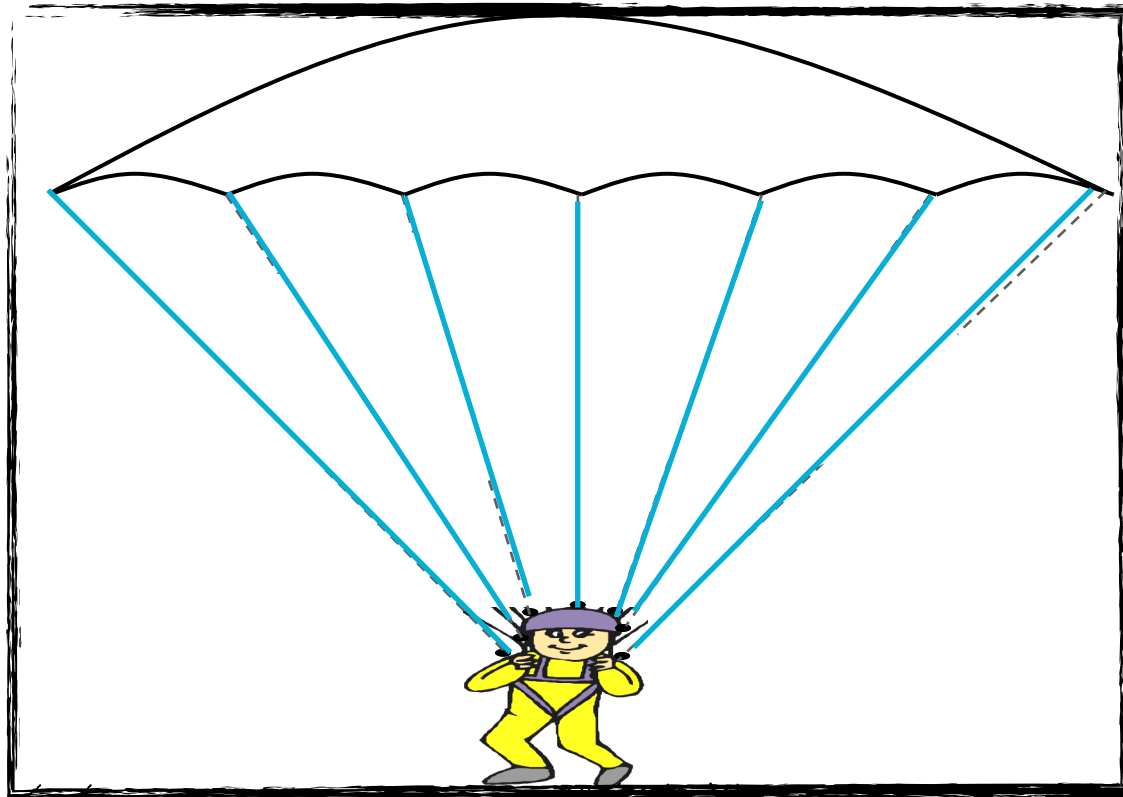

5. Avec ta règle, relie chaque pêcheur à son poisson. (voir annexes)

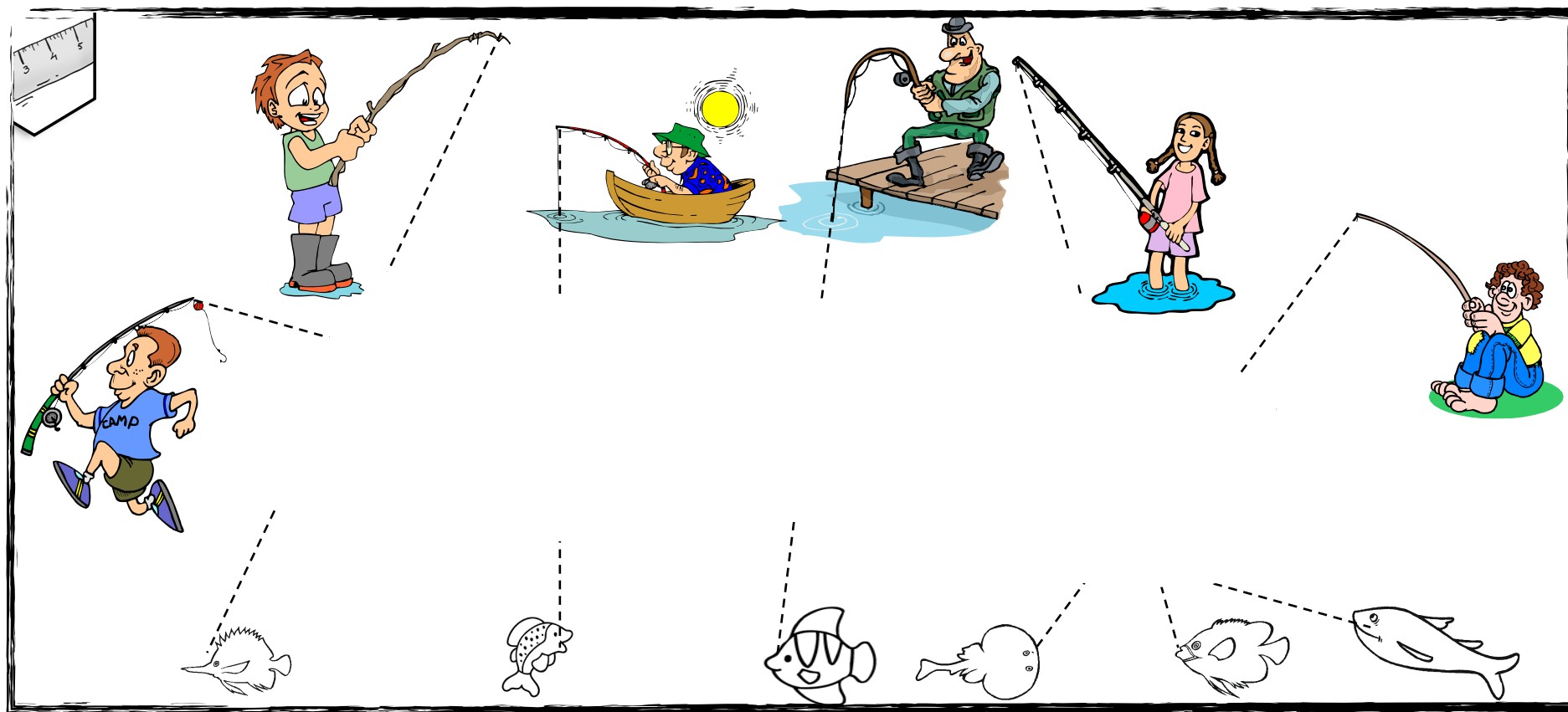

Correction

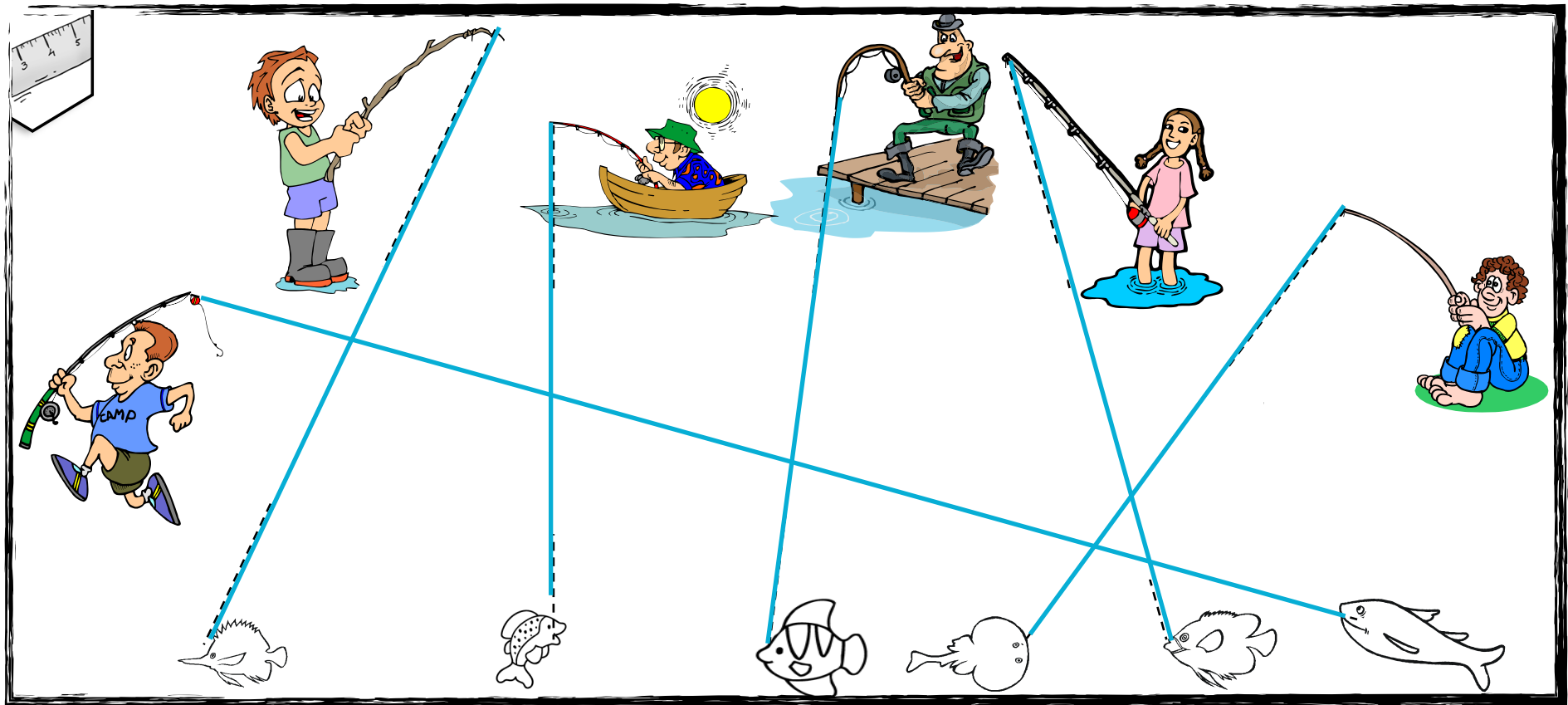

6. Avec ta règle, relie les points dans l'ordre. (voir annexes)

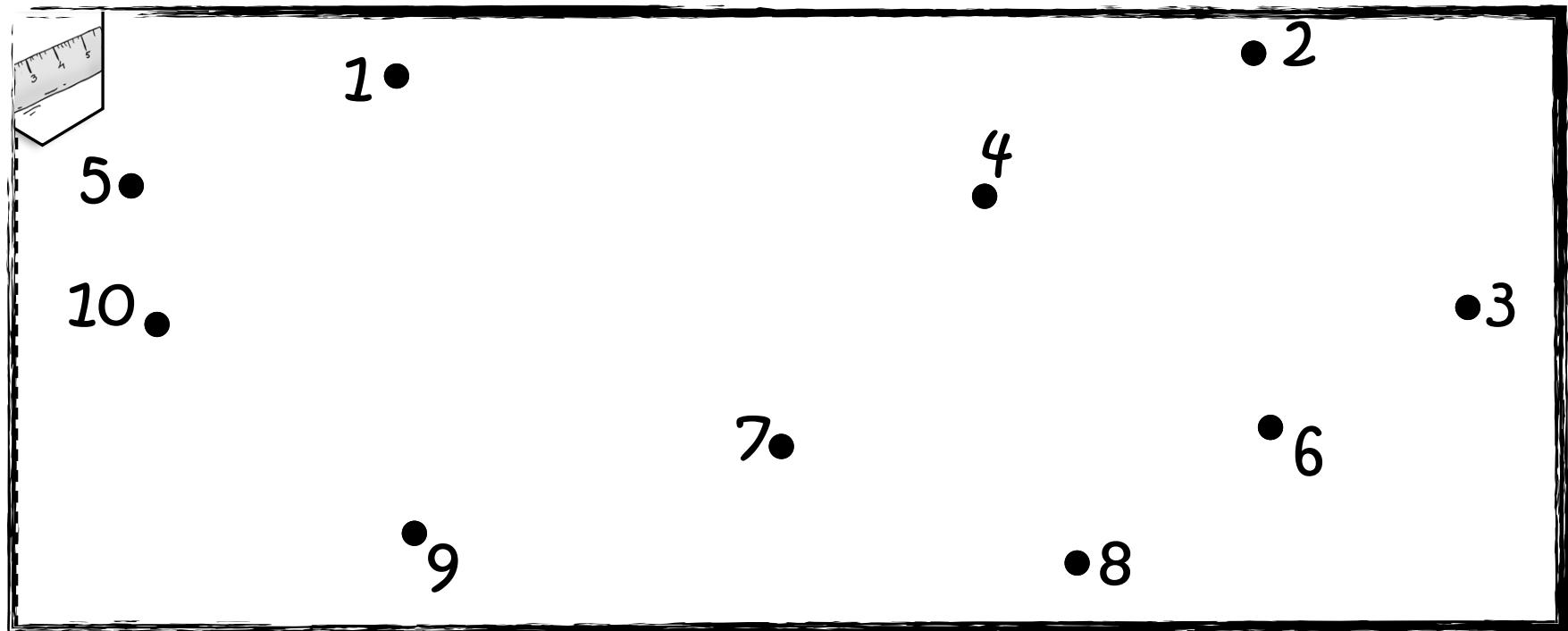

Correction

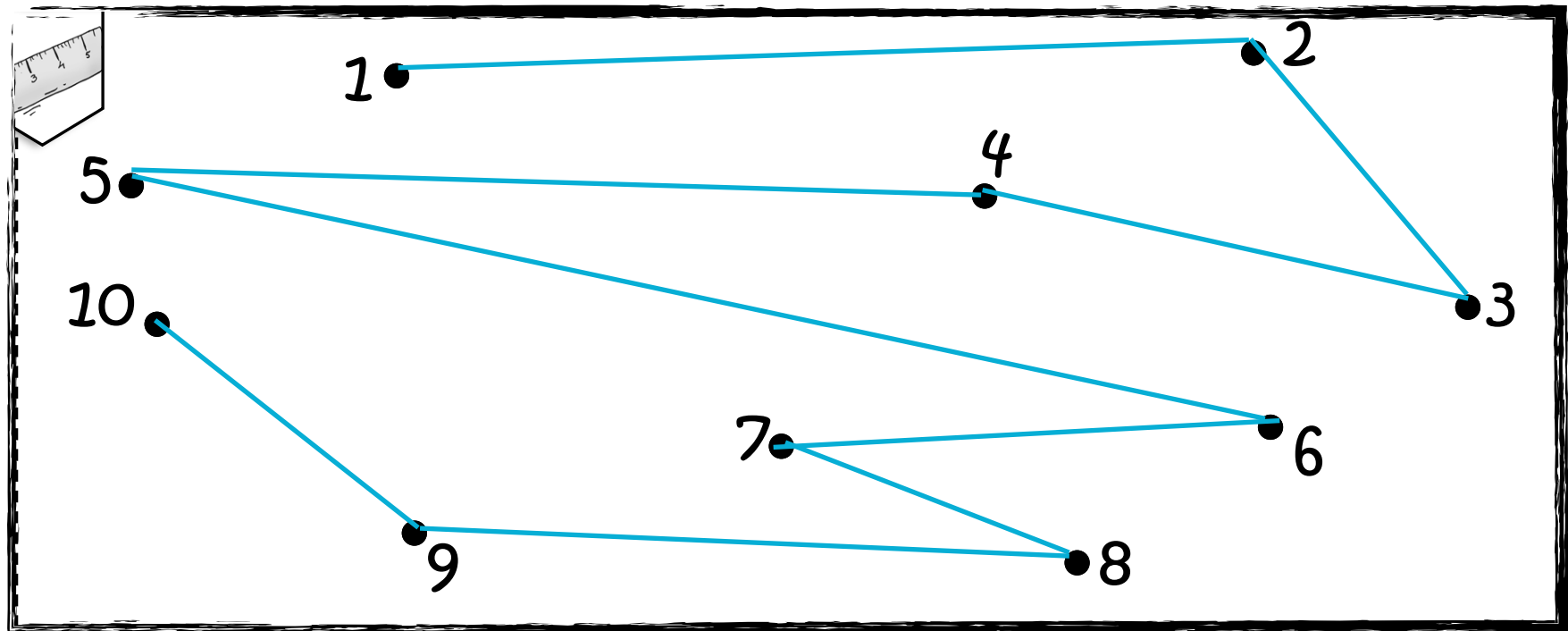

7. Avec ta règle, relie les points qui ont la même forme. (voir annexes)

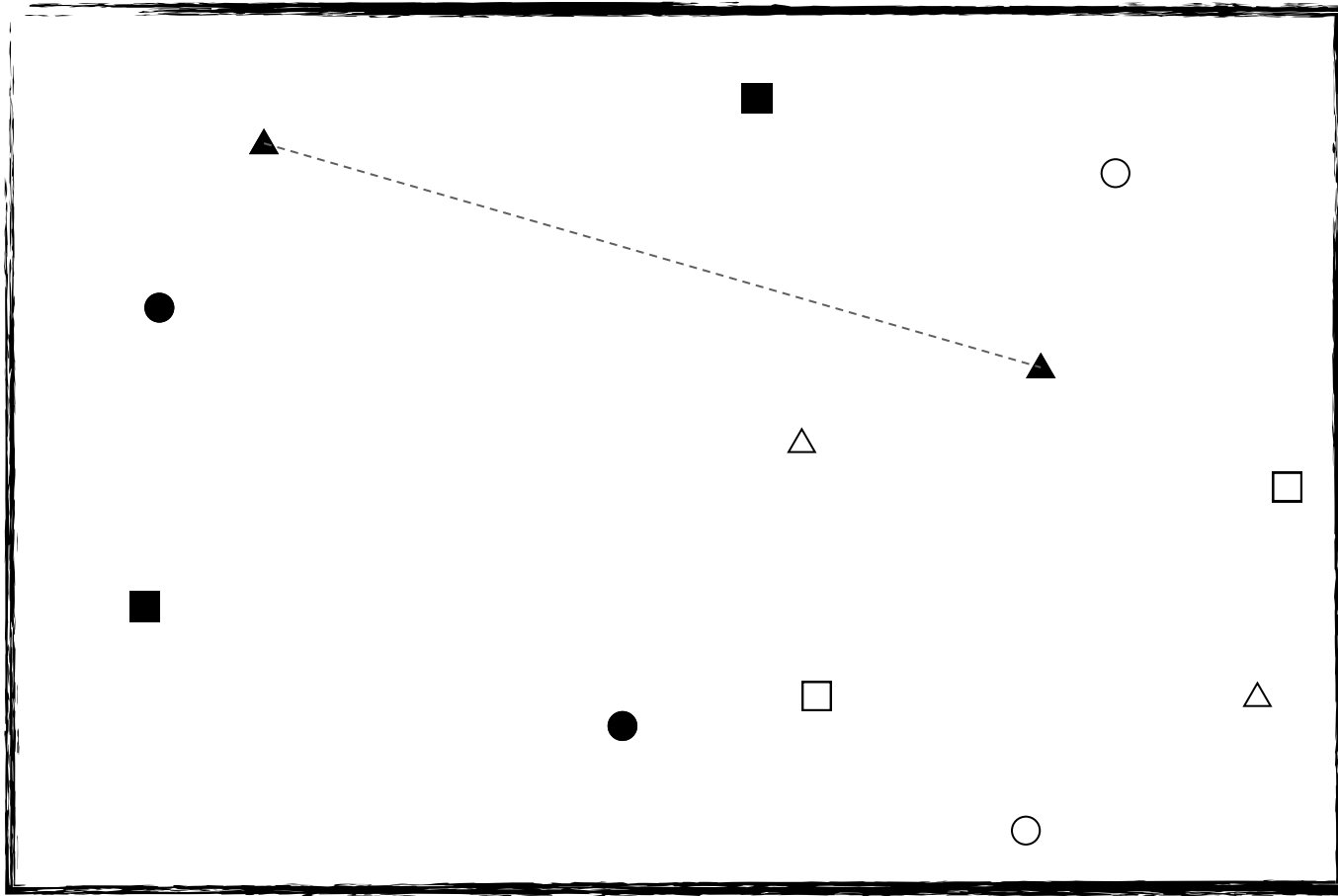

Correction

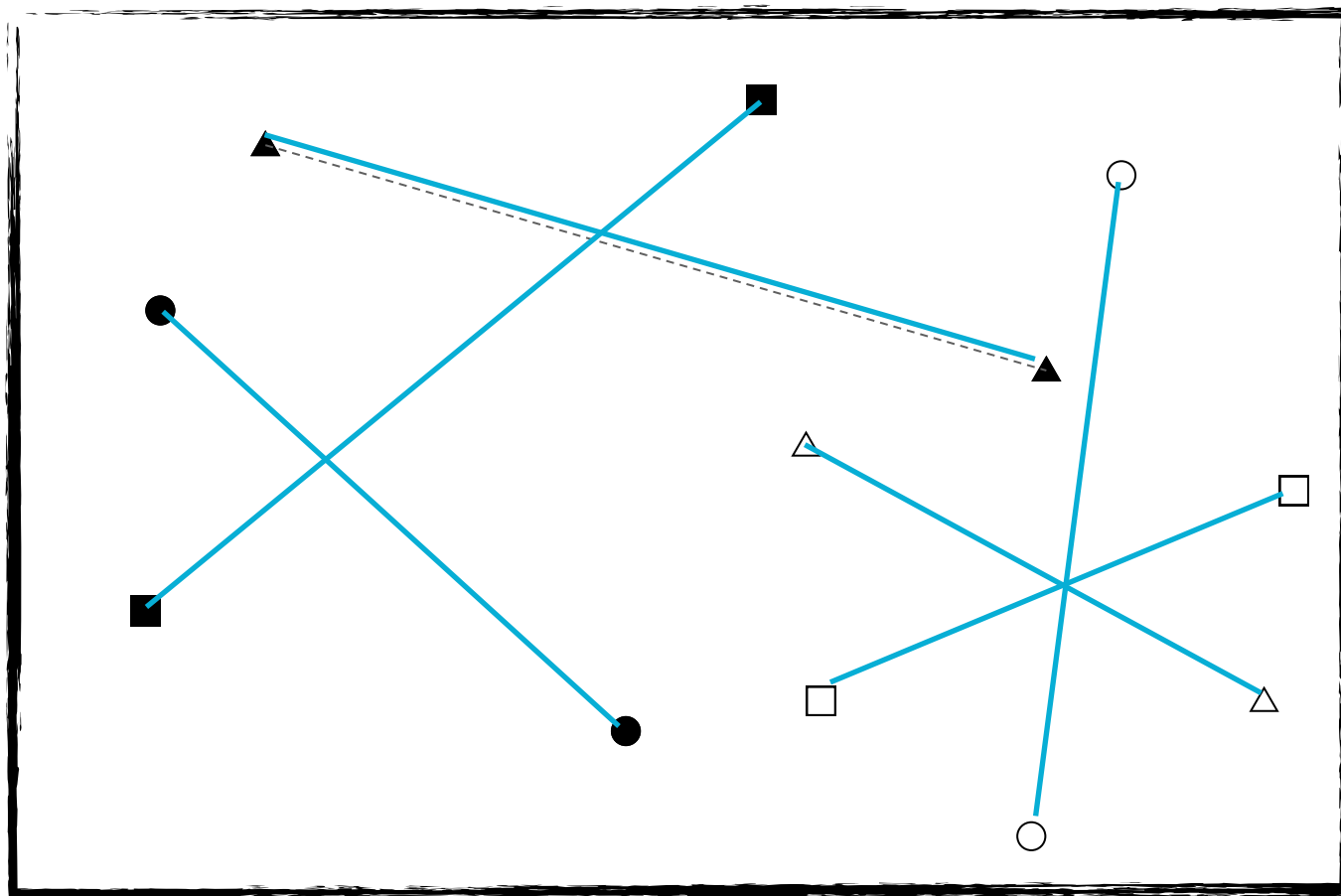

8. Reproduis avec ta règle: (voir annexes)

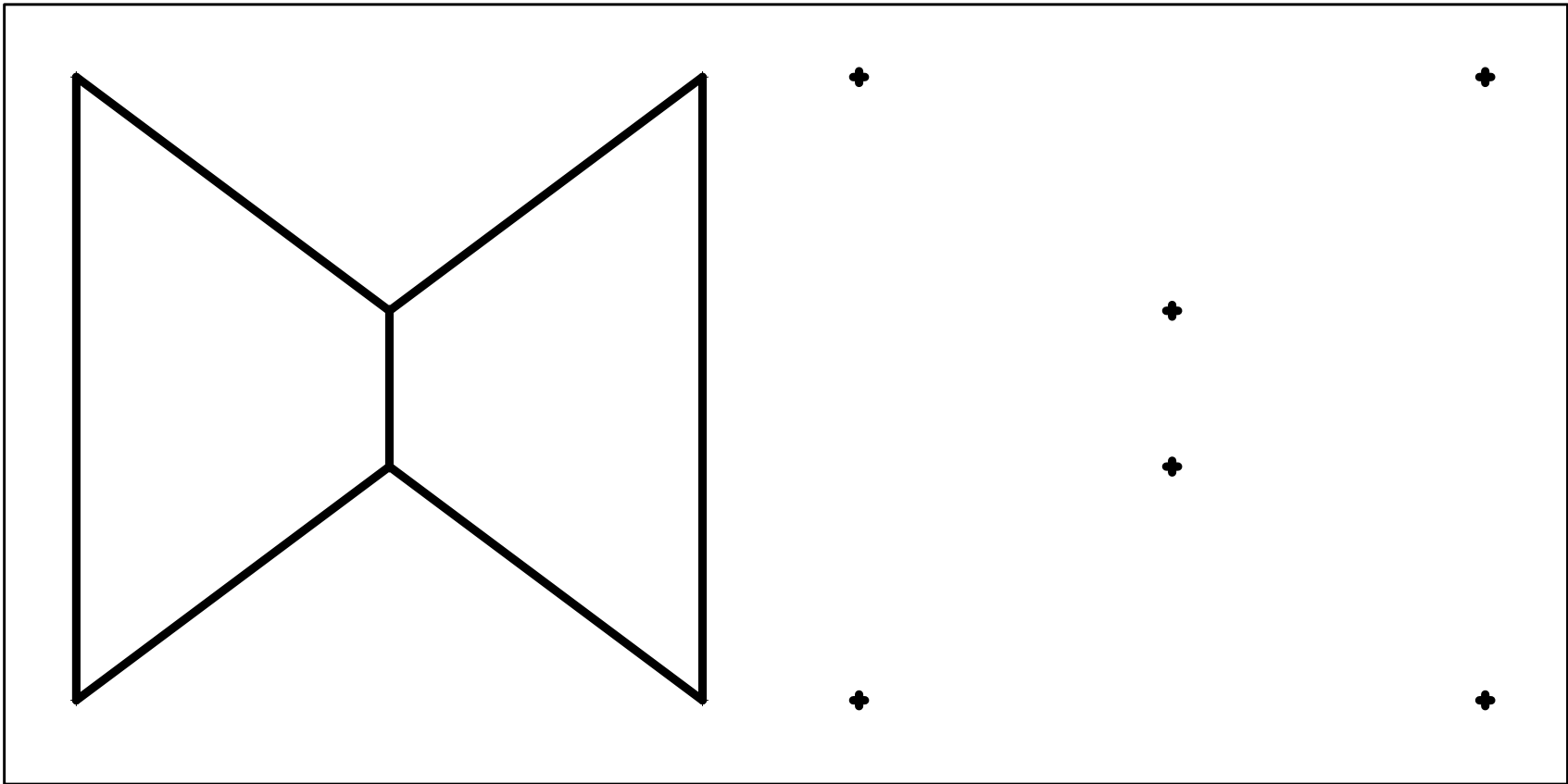

Correction :

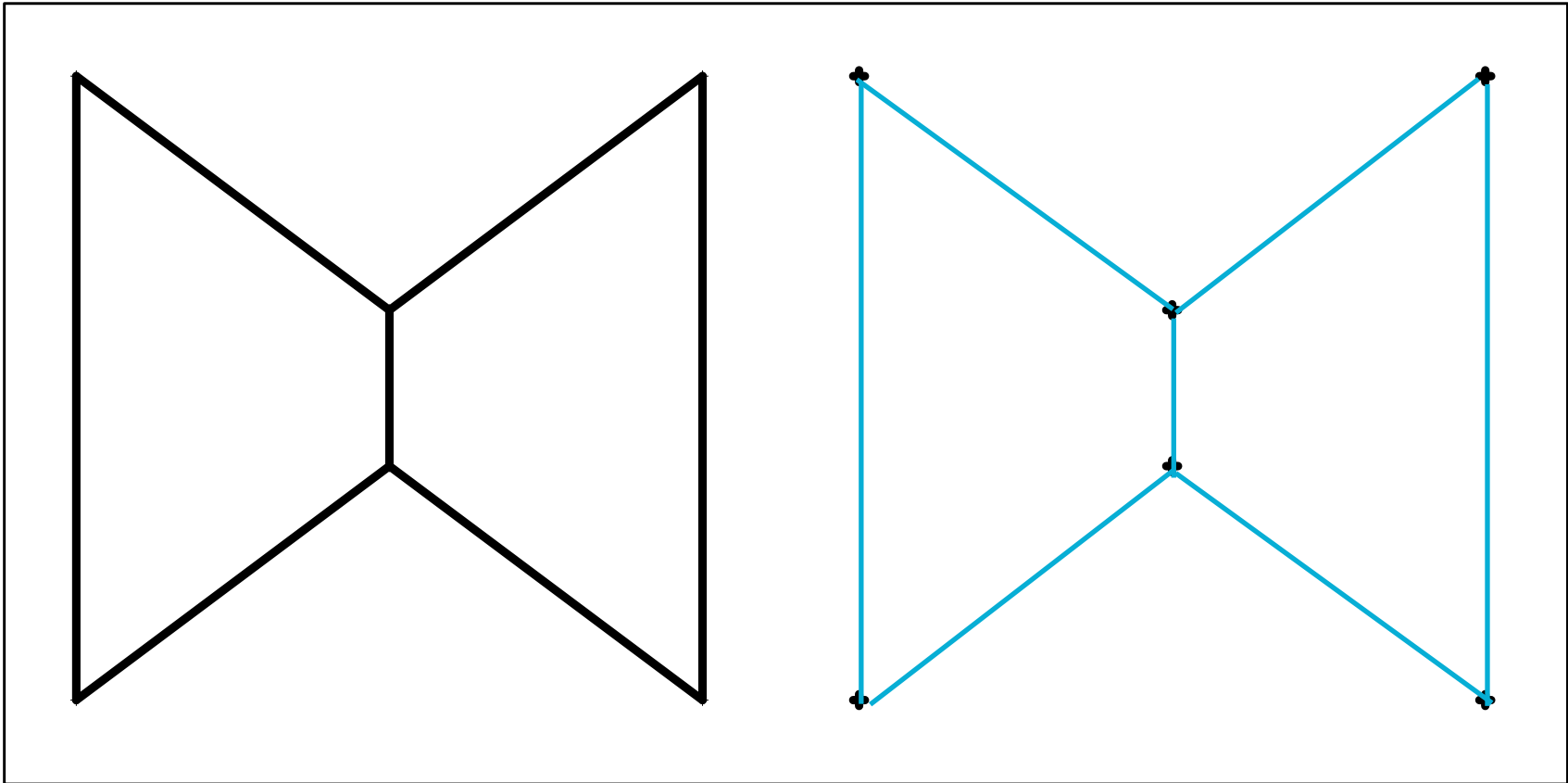

9. Reproduis avec ta règle: (voir annexes)

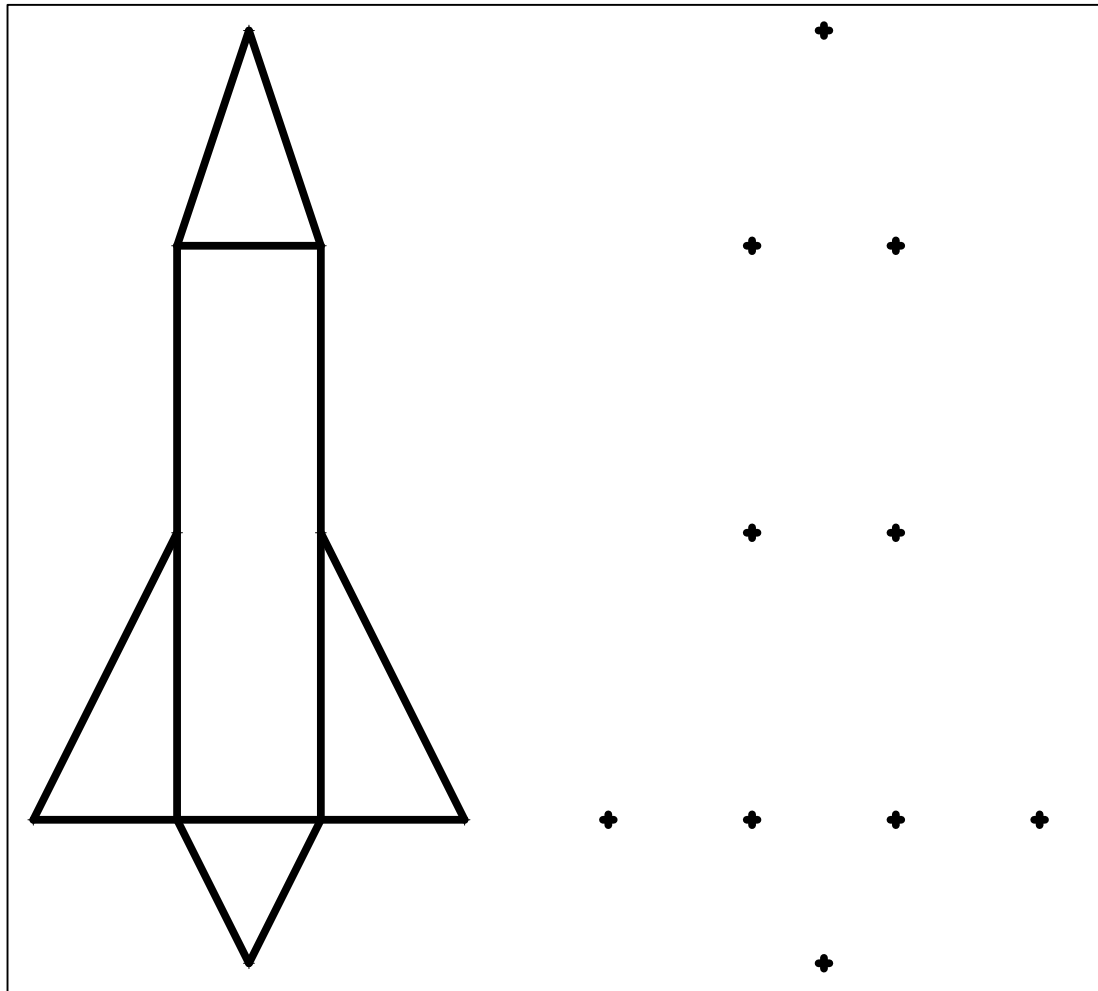

Correction

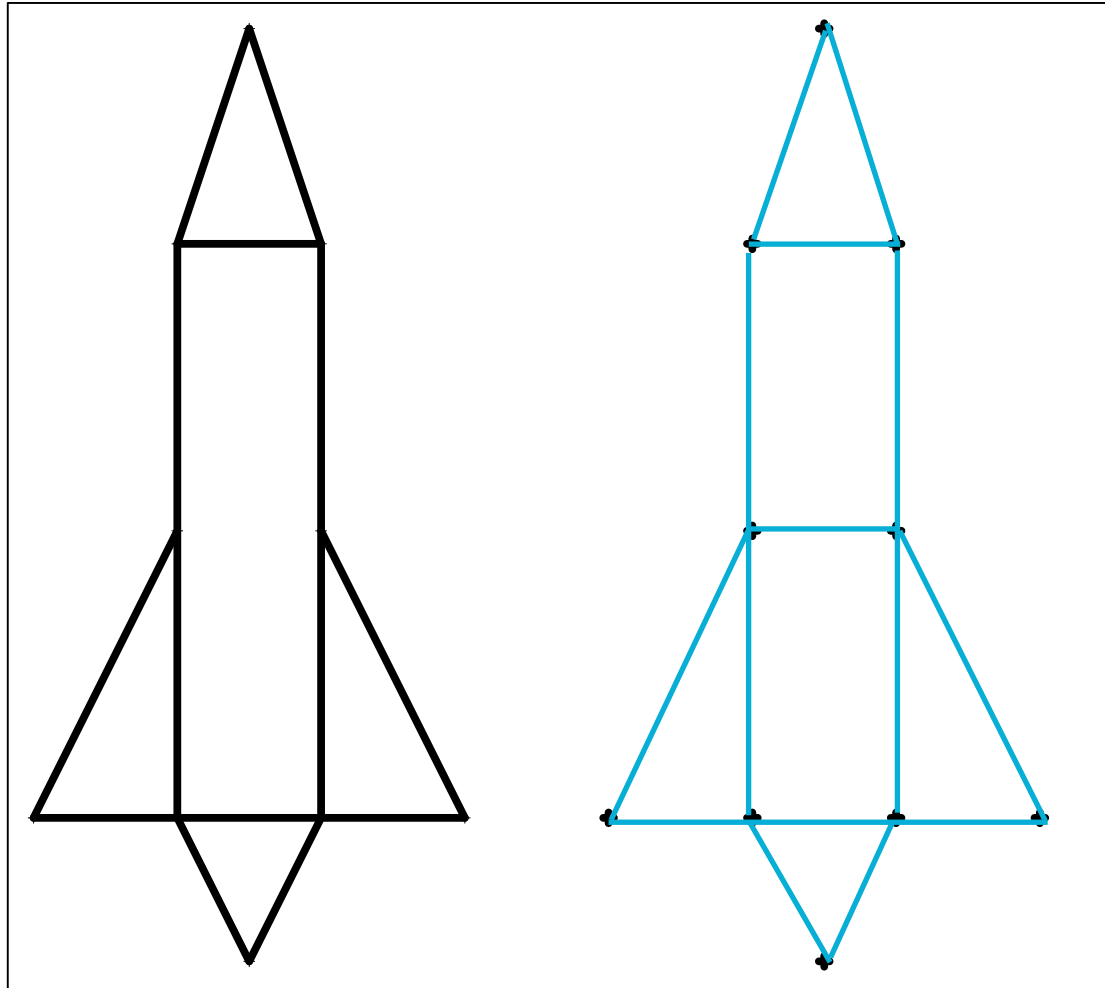

10. Reproduis avec ta règle: (voir annexes)

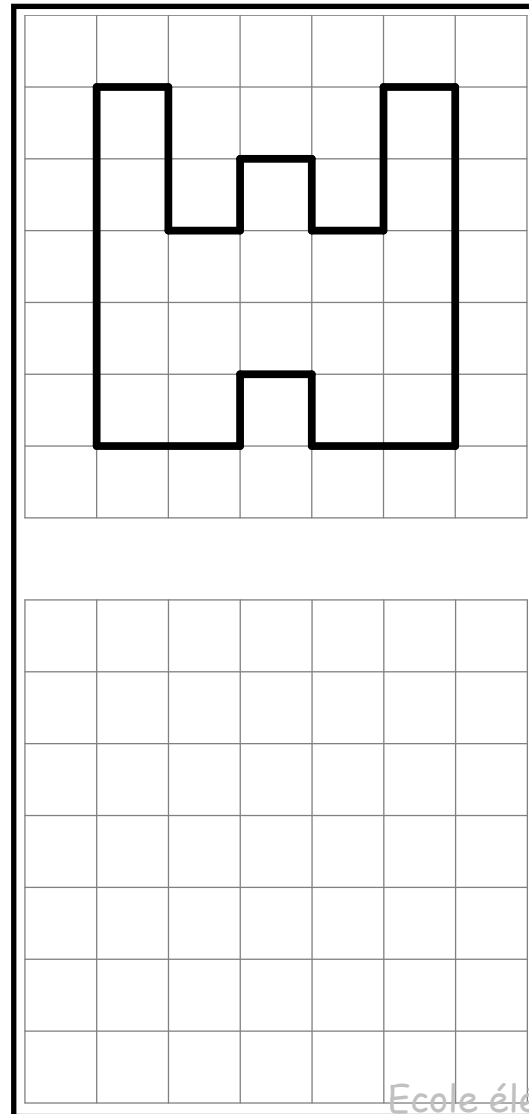

Correction

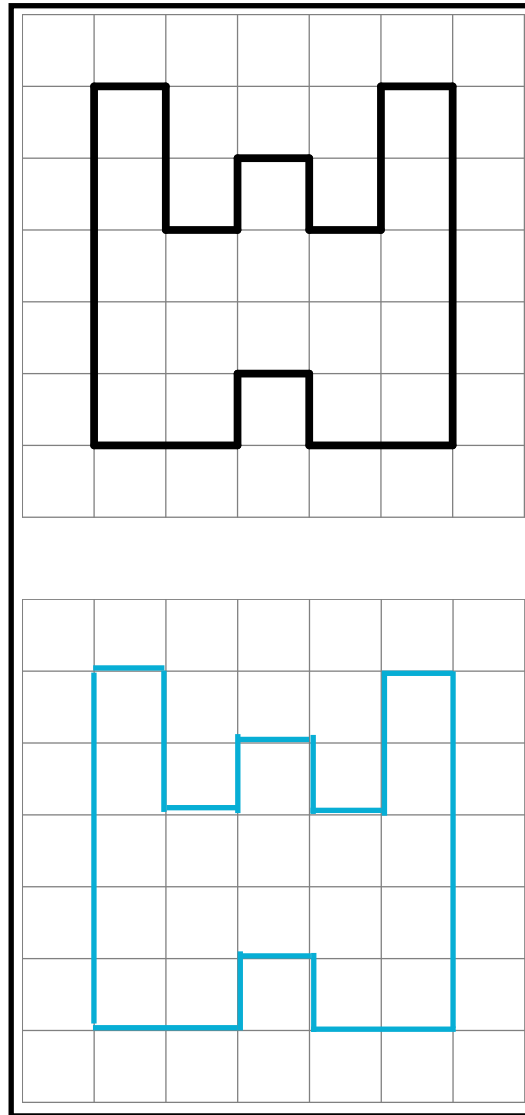

Annexes géométrie: fiches à distribuer

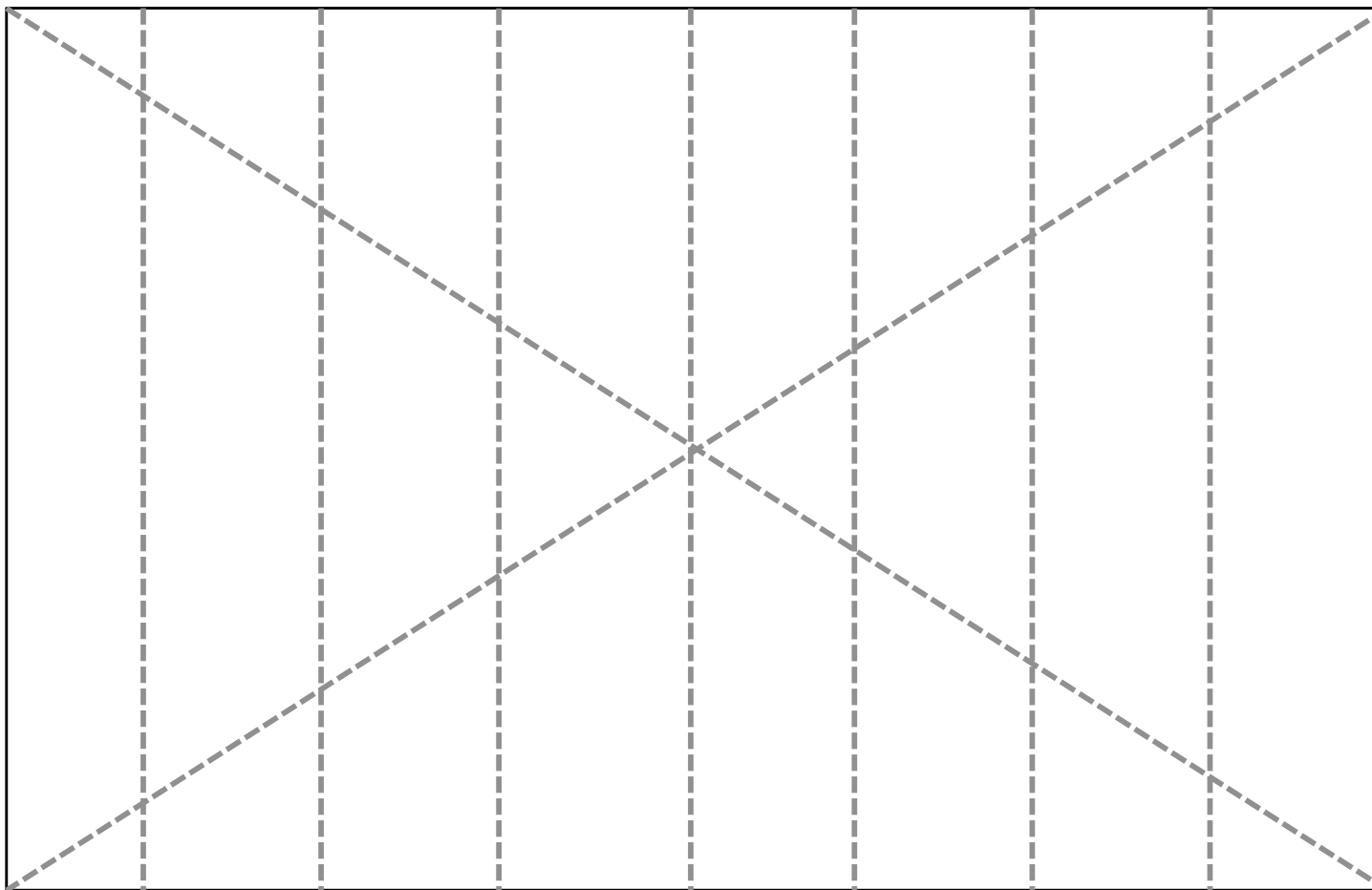

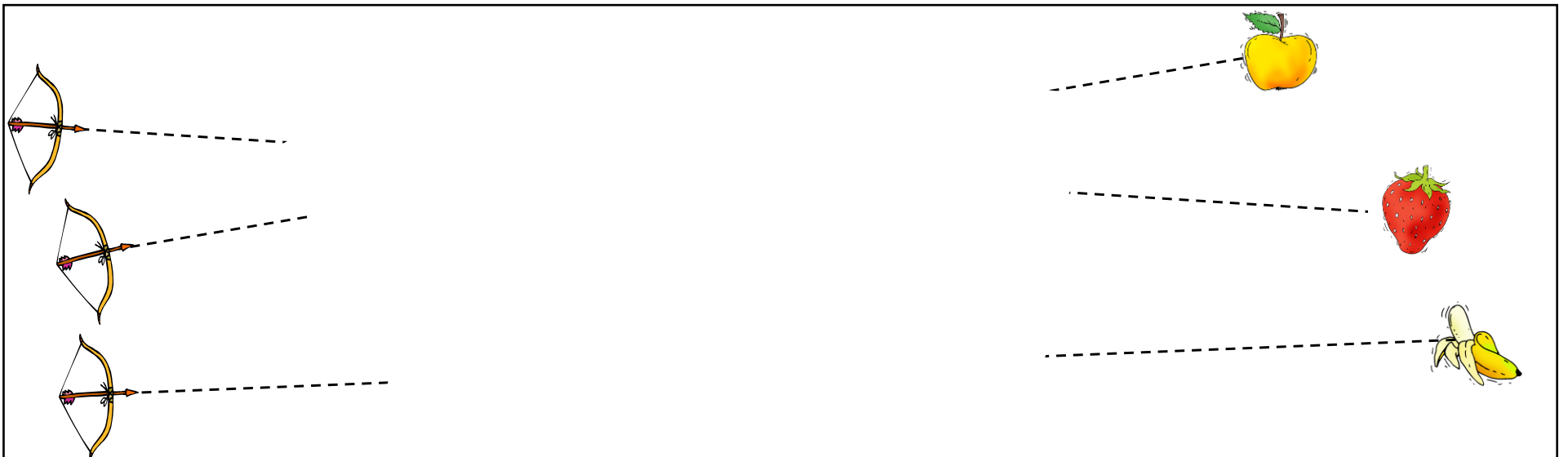
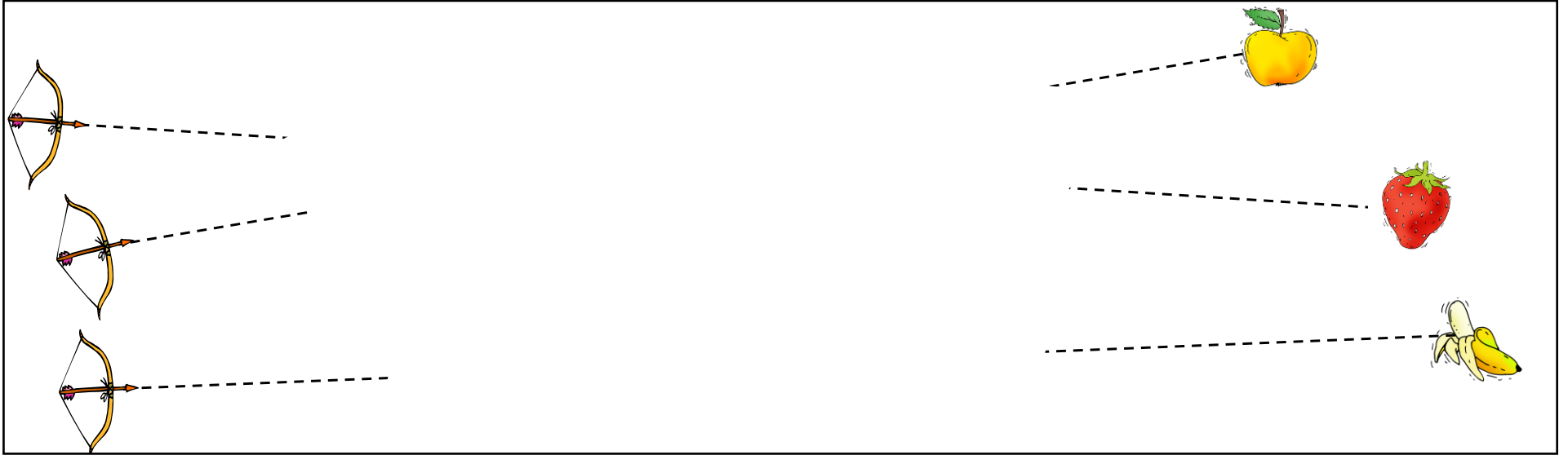

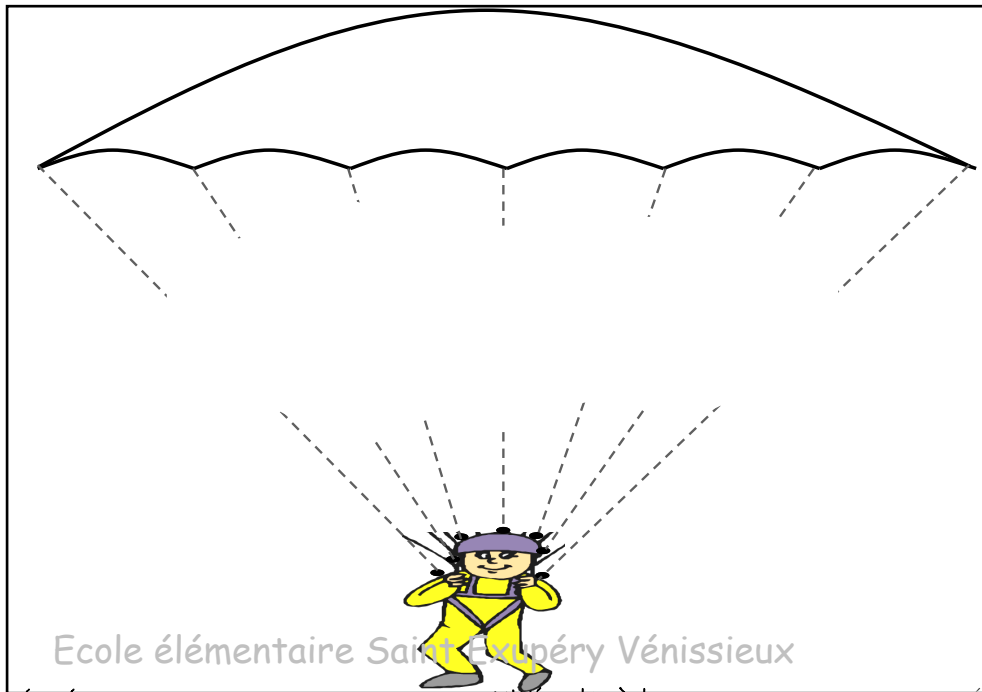
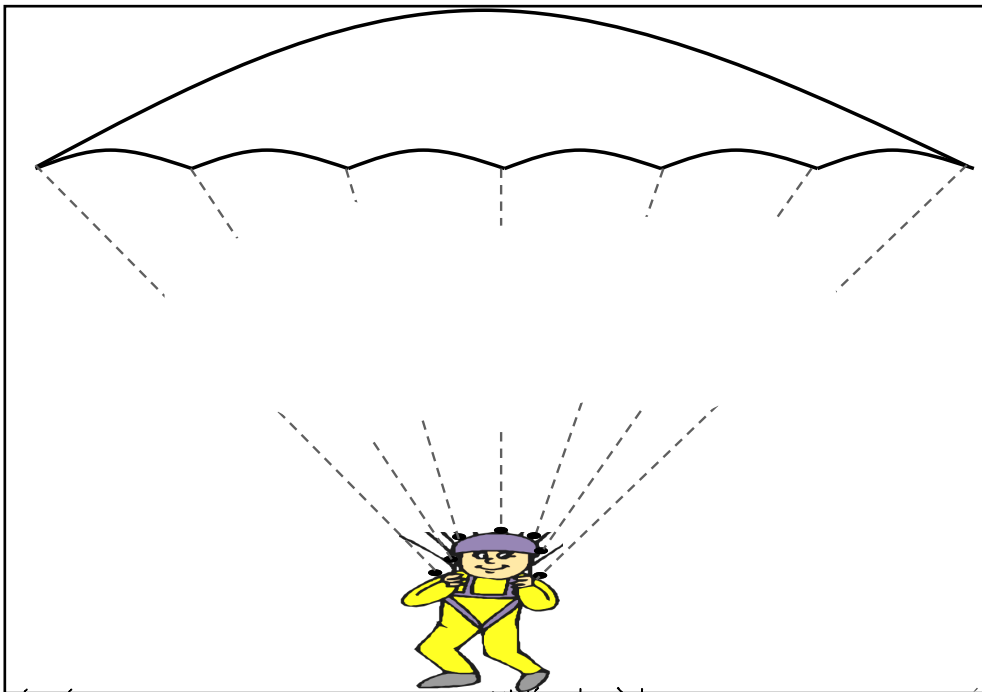
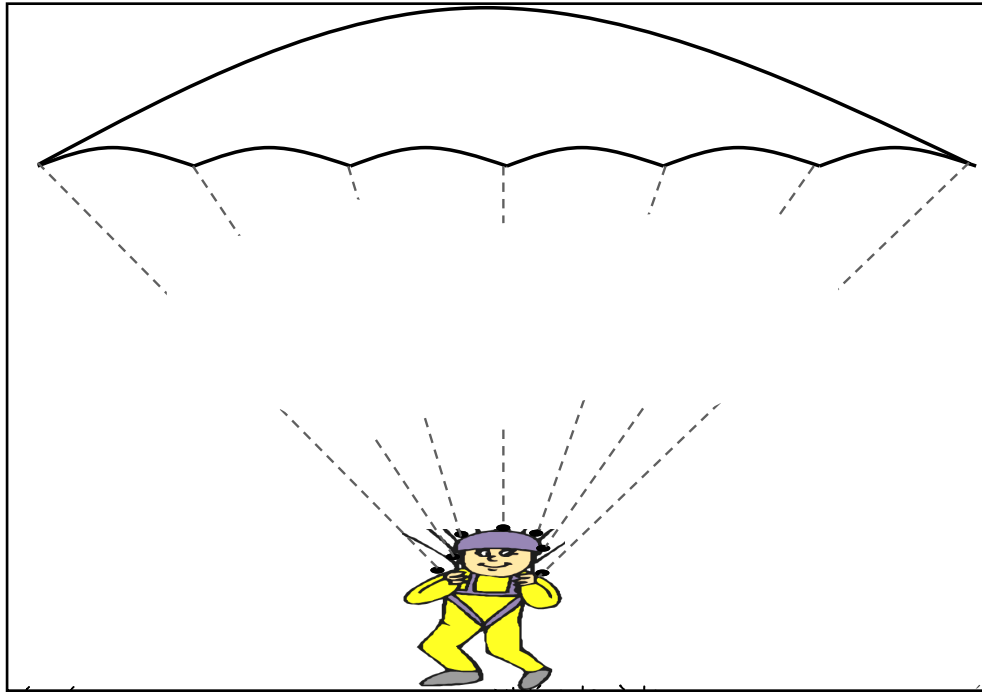
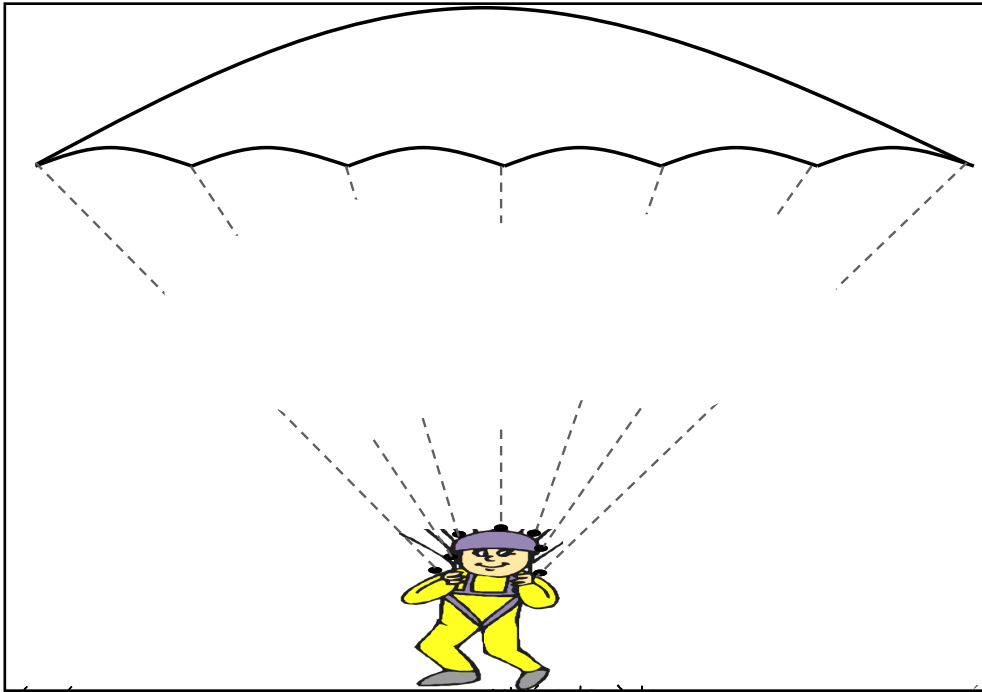

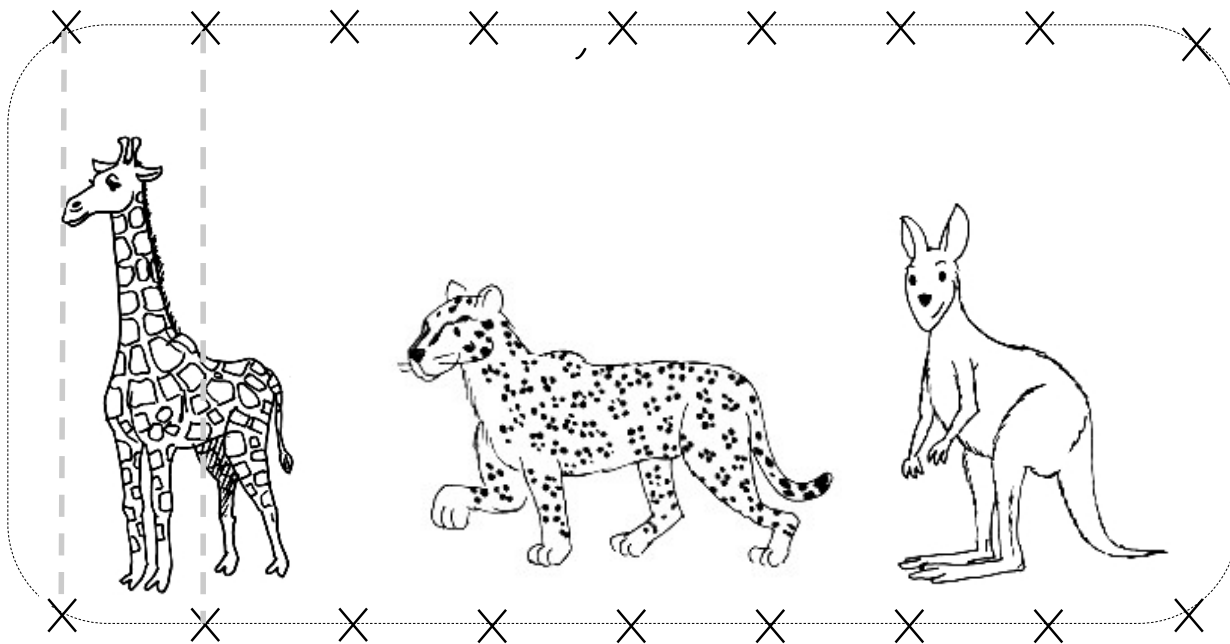
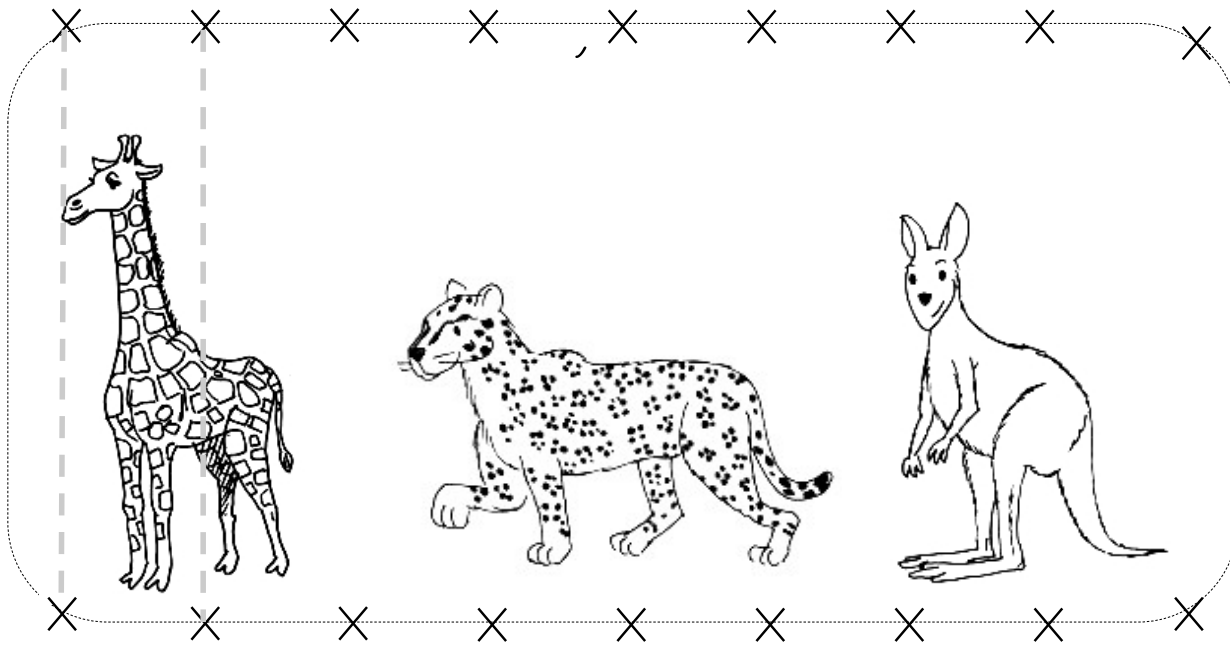

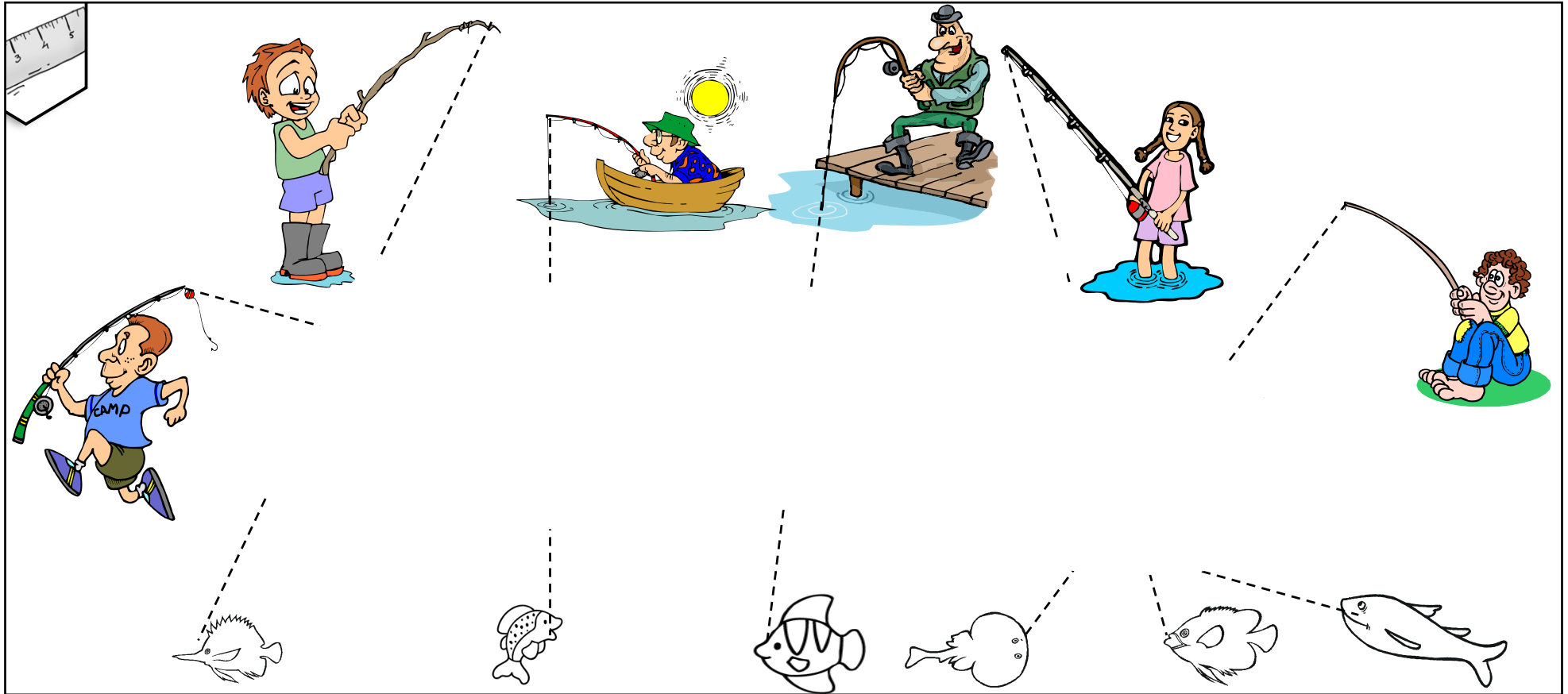

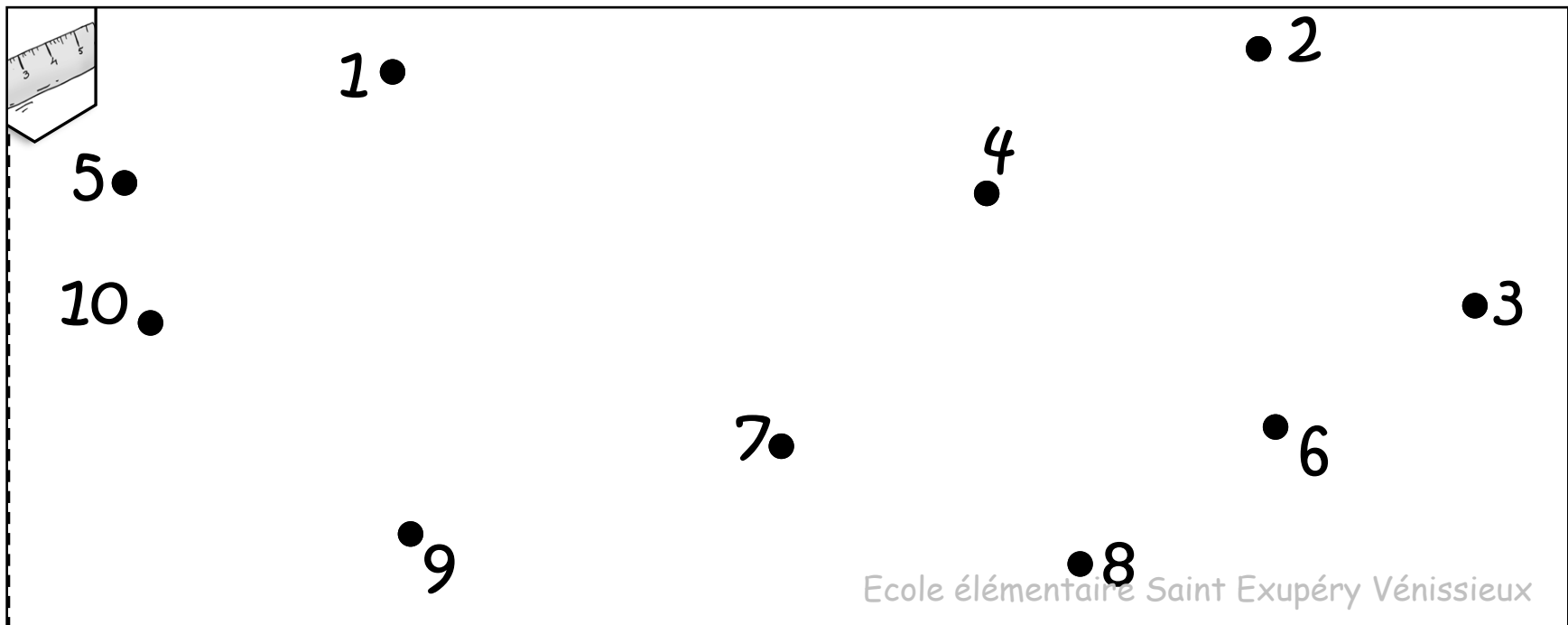
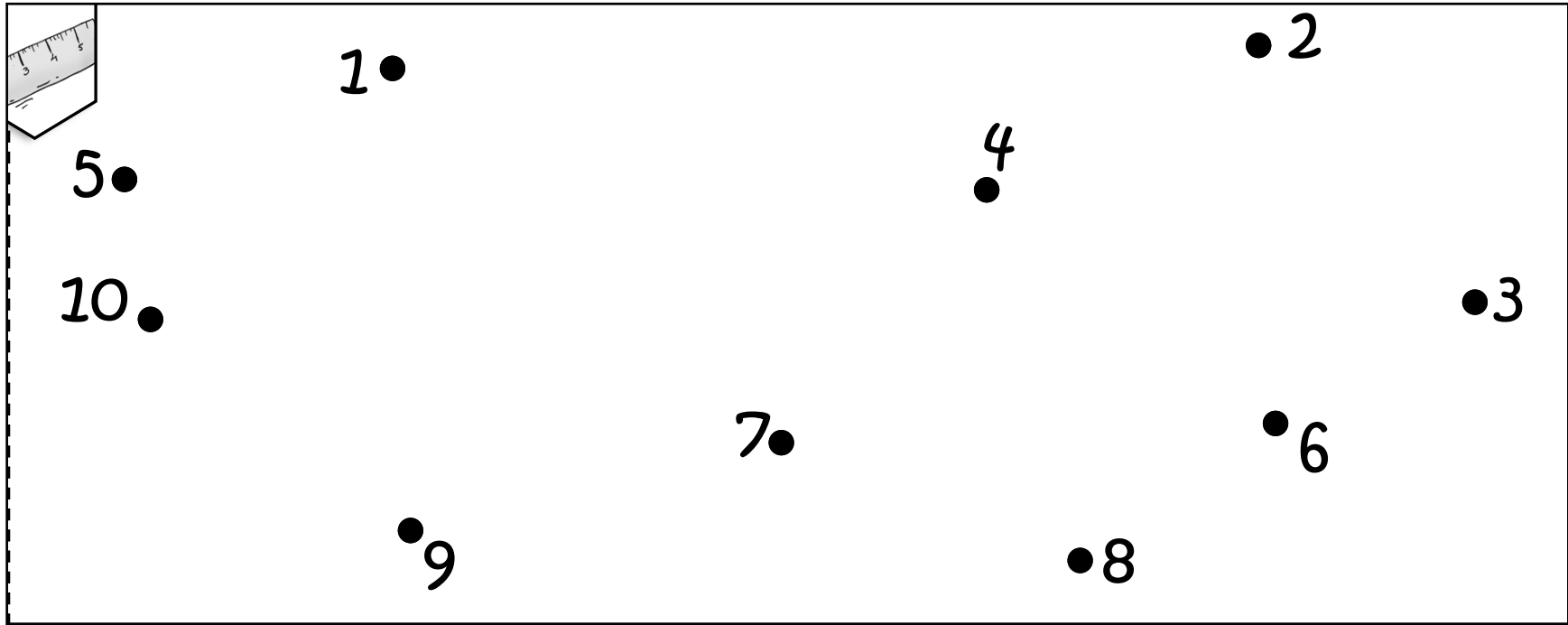

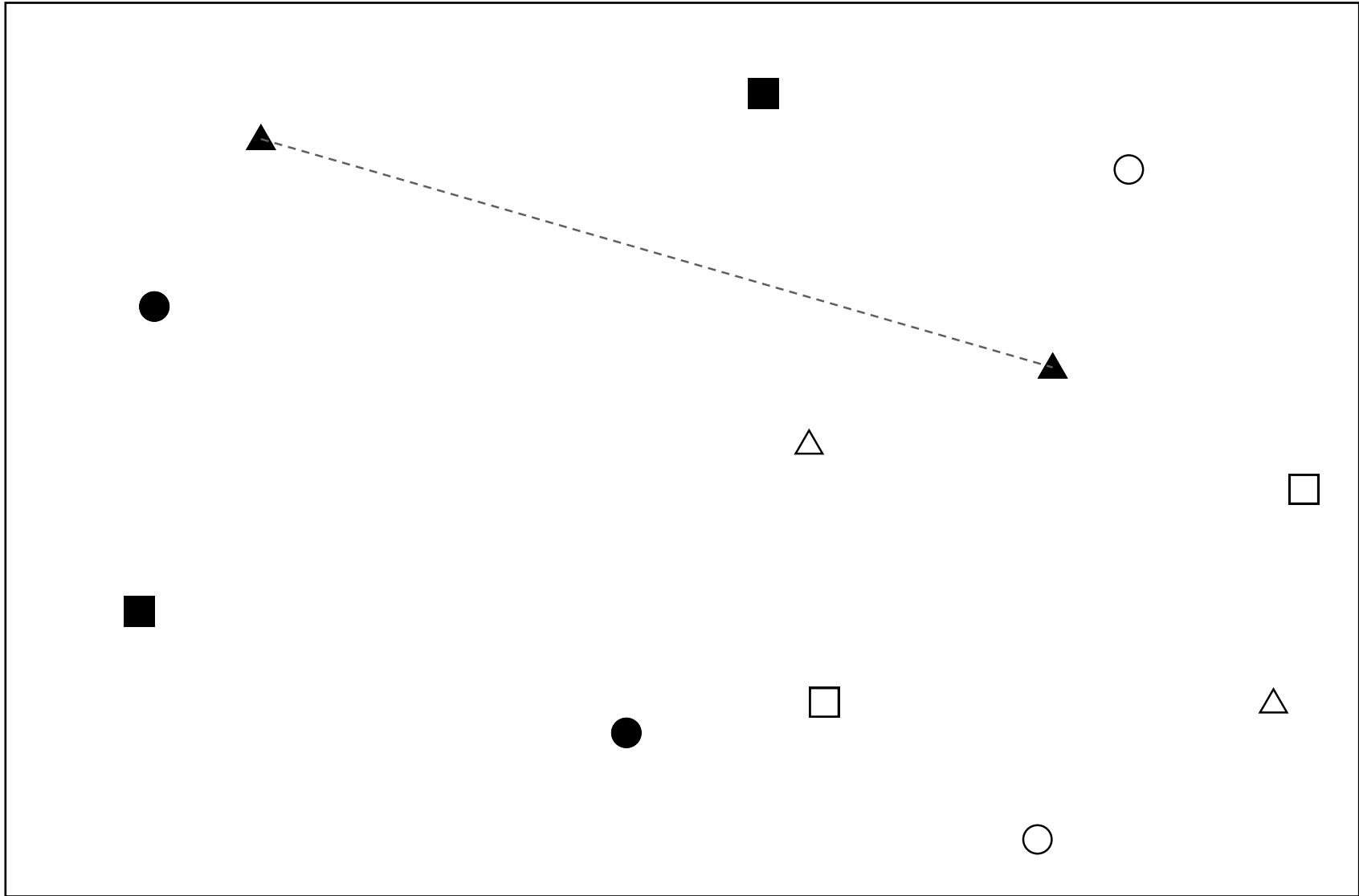

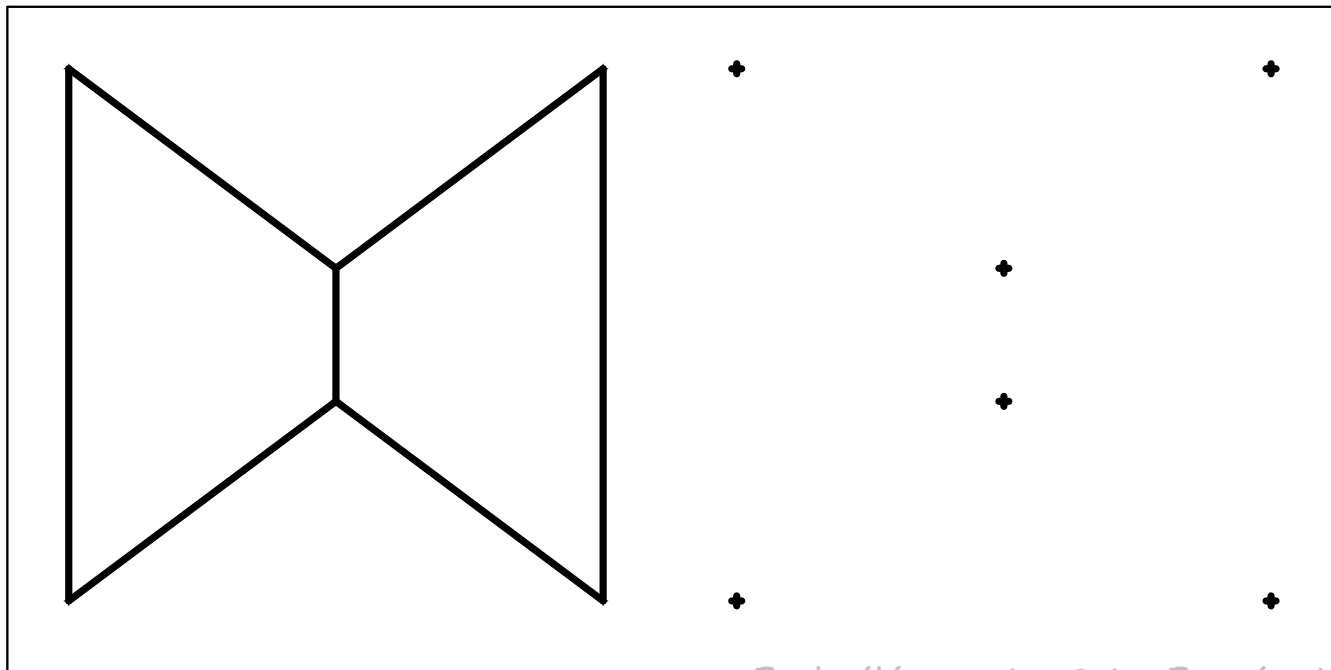
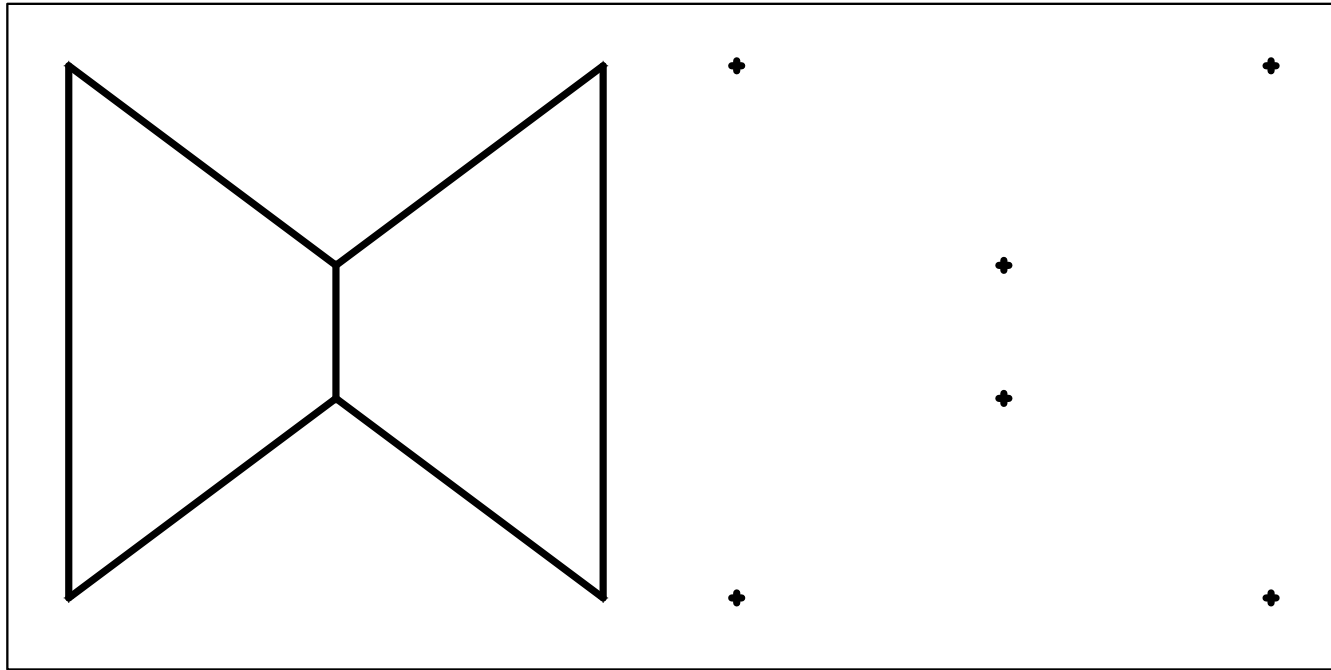

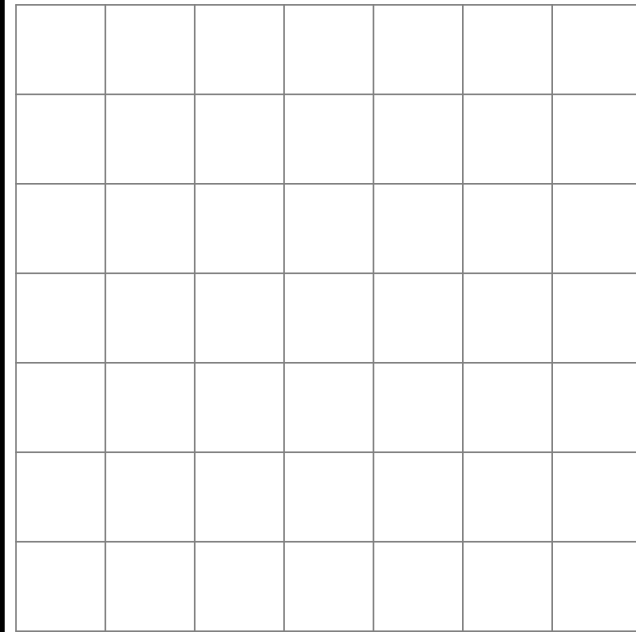
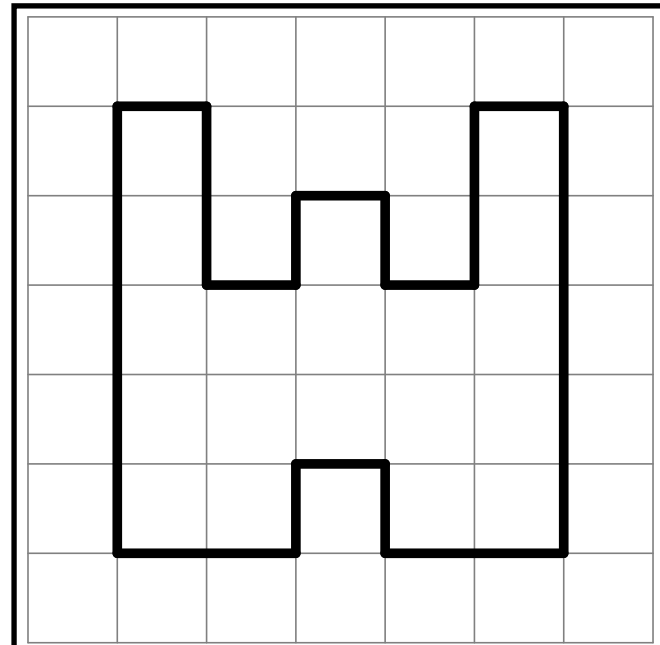
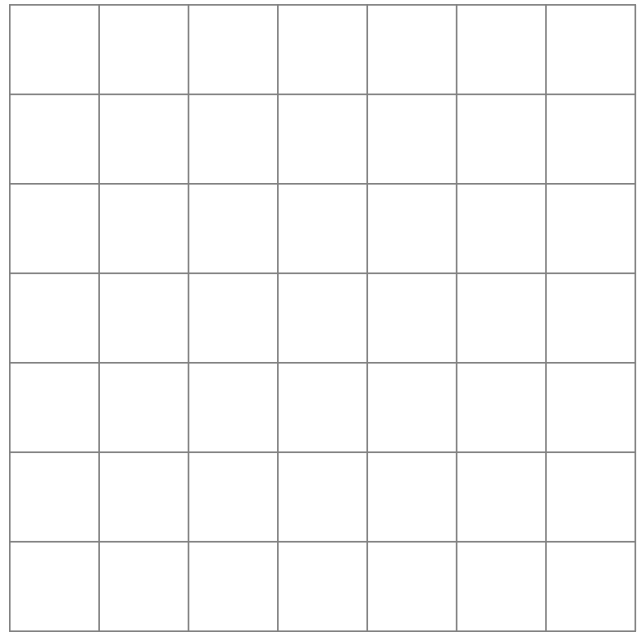
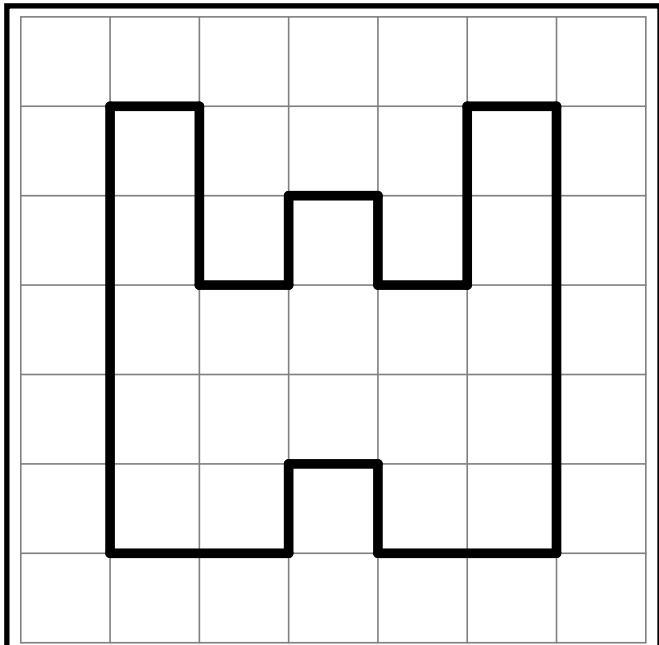

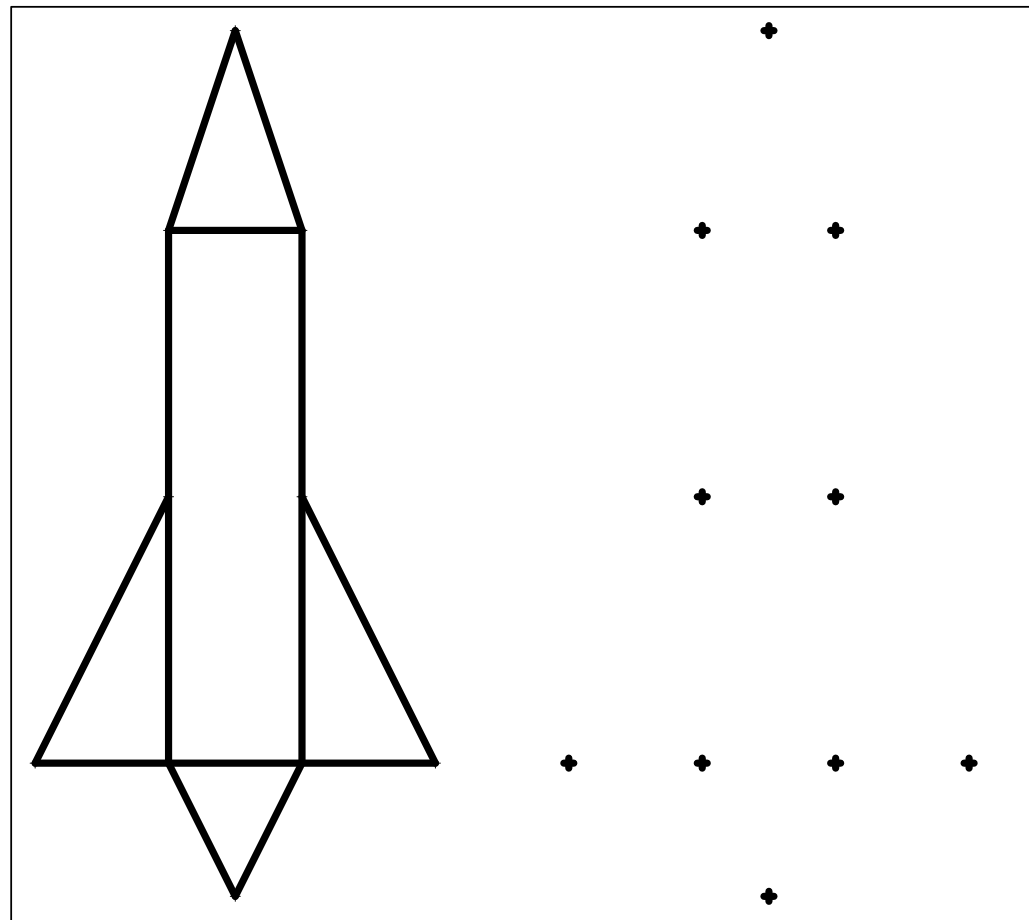
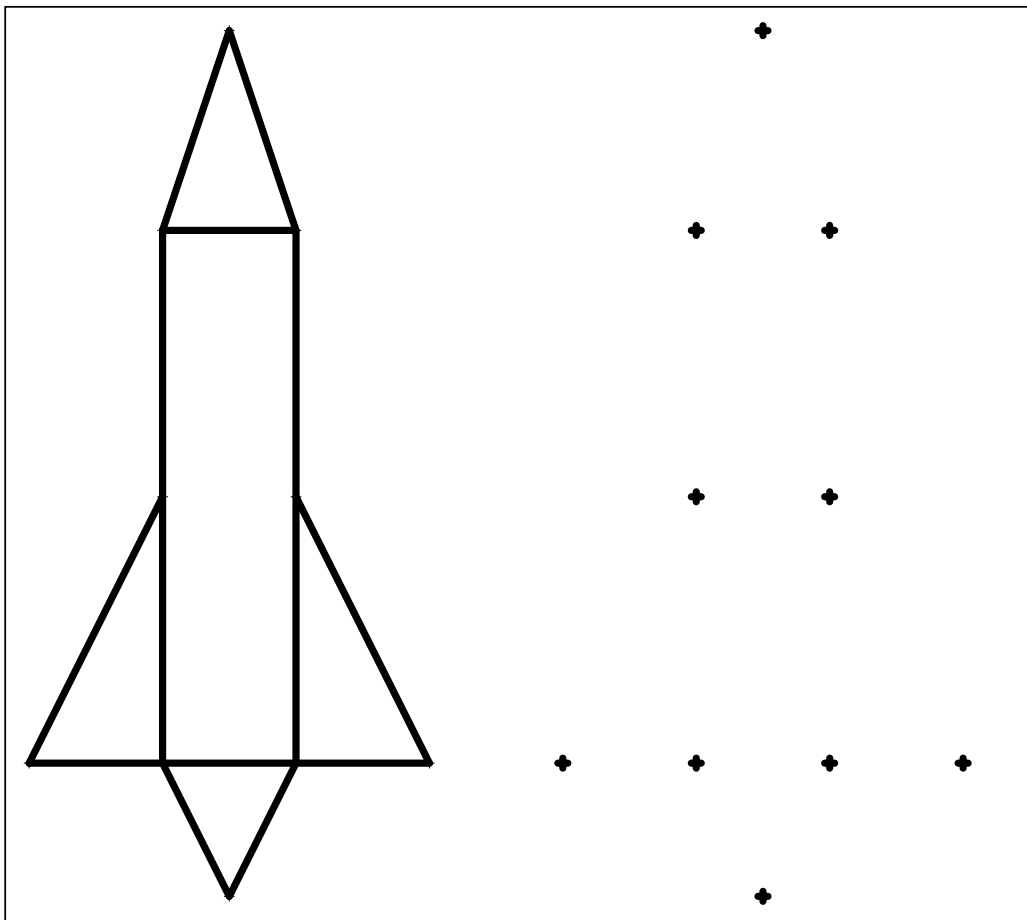



Reconnaitre des
figures
géométriques

1. Sur ton ardoise, écris quelles figures sont des triangles.

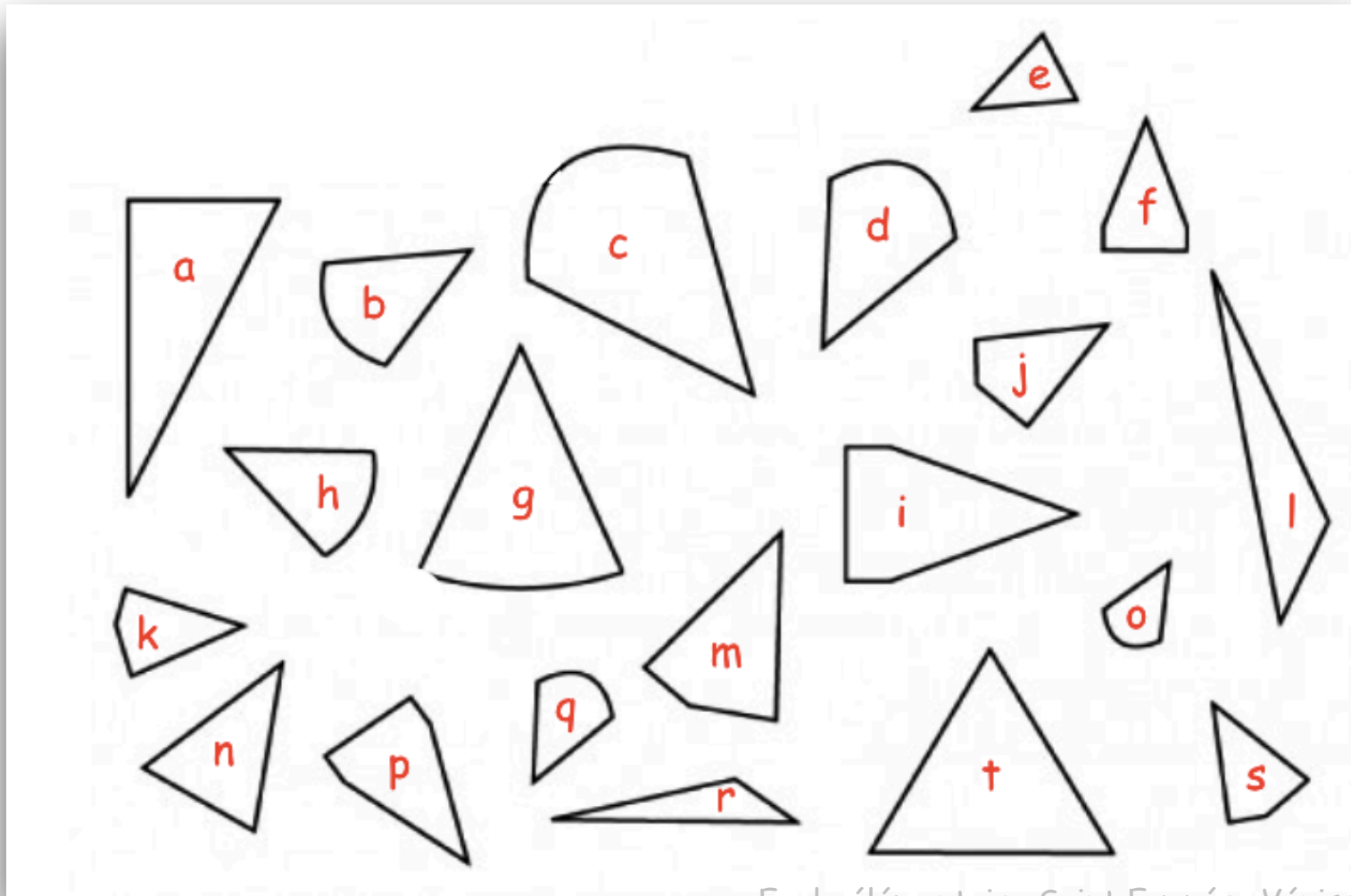

Correction : a e l n r t

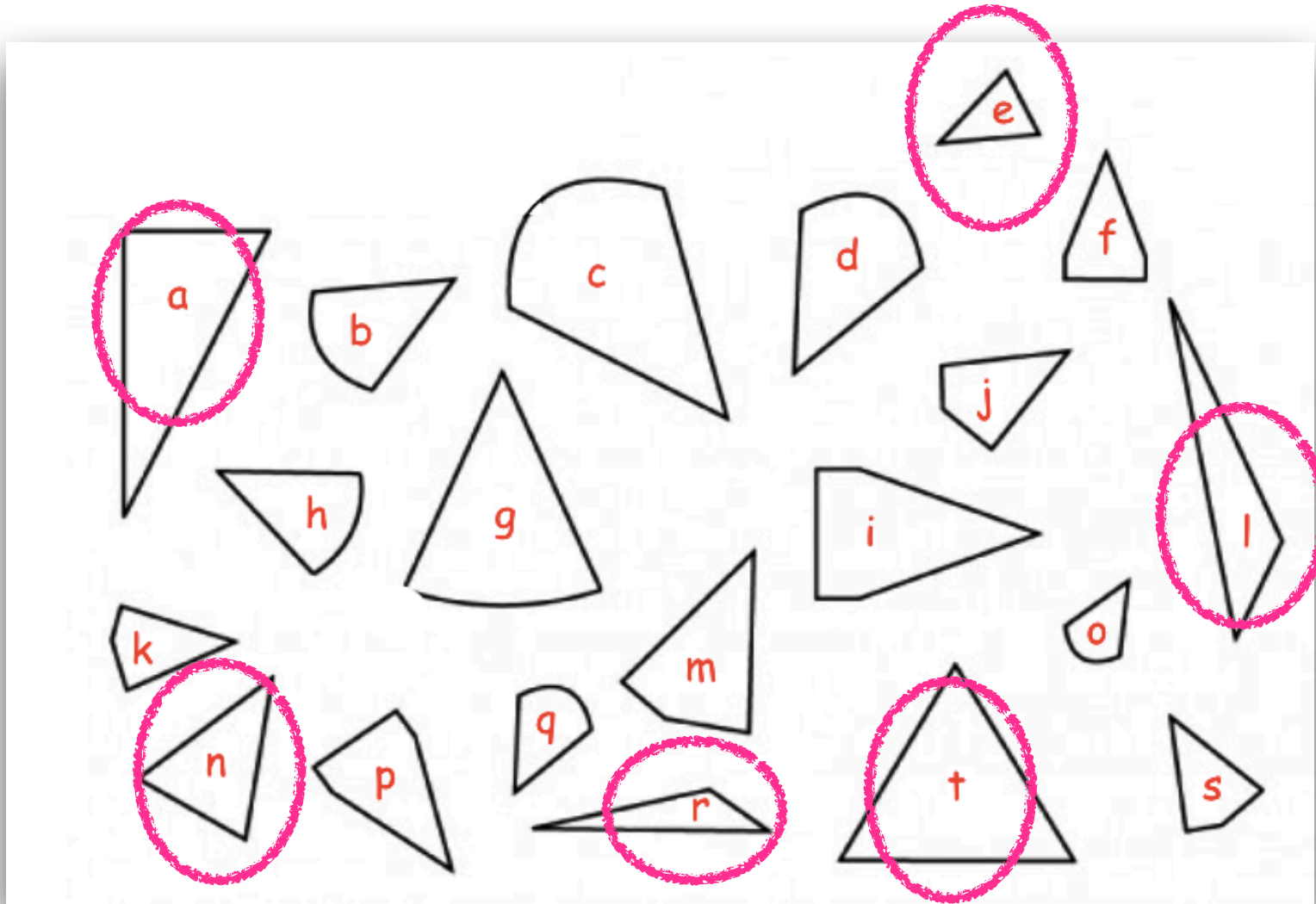

2. Sur ton ardoise, écris quelles figures sont des cercles.

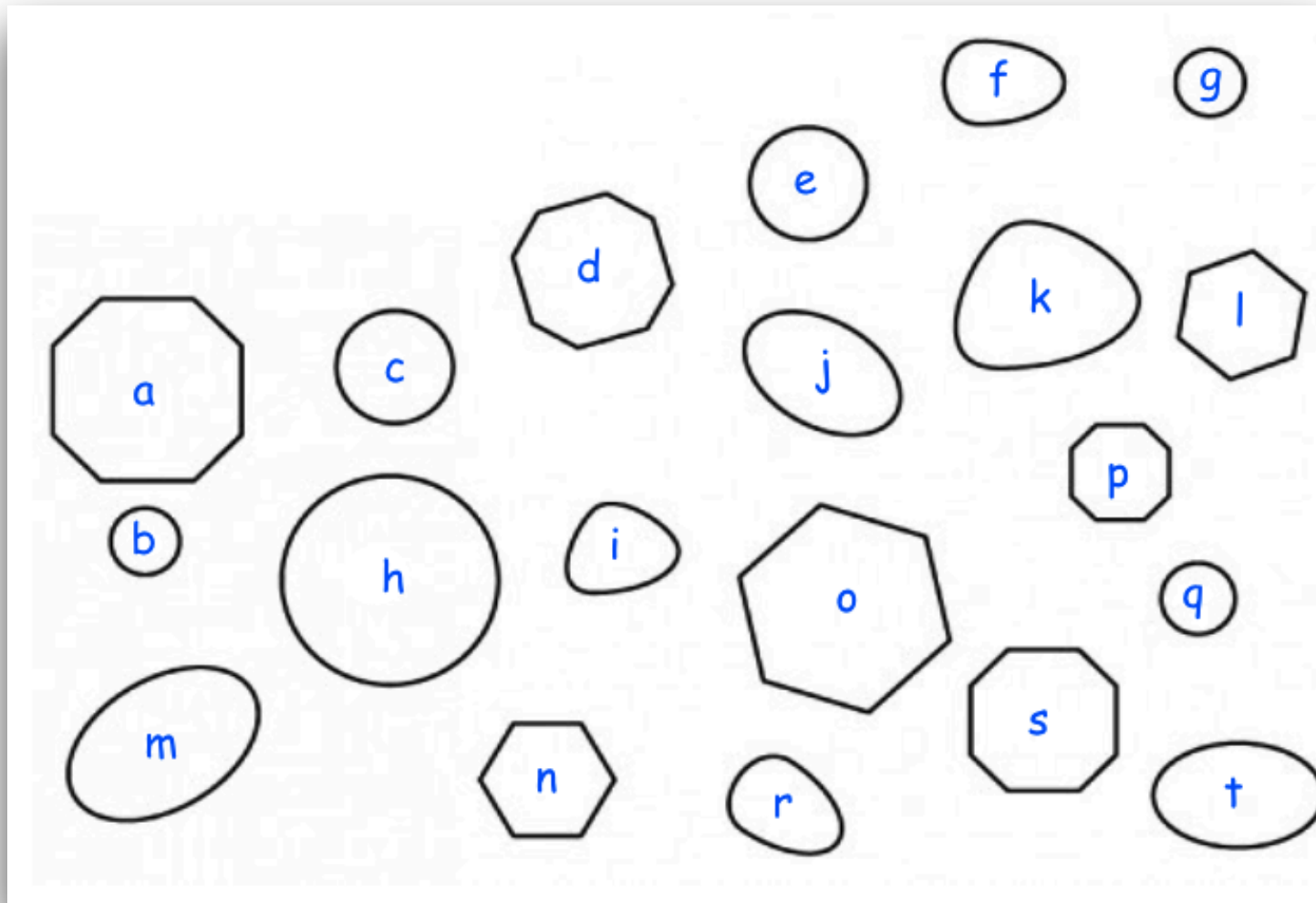

Correction : b c e g h q

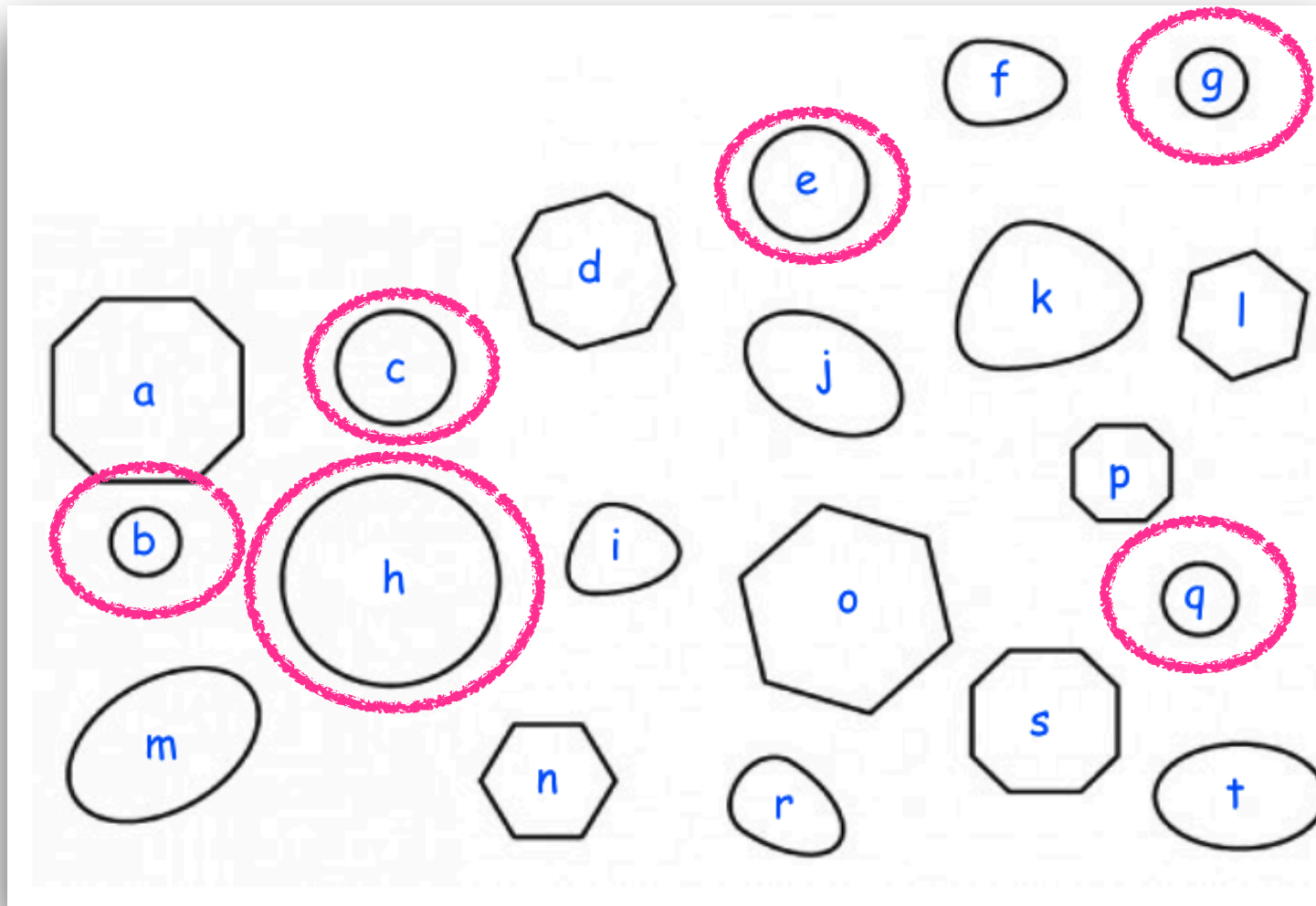

3. Sur ton ardoise, écris quelles figures sont des carrés.

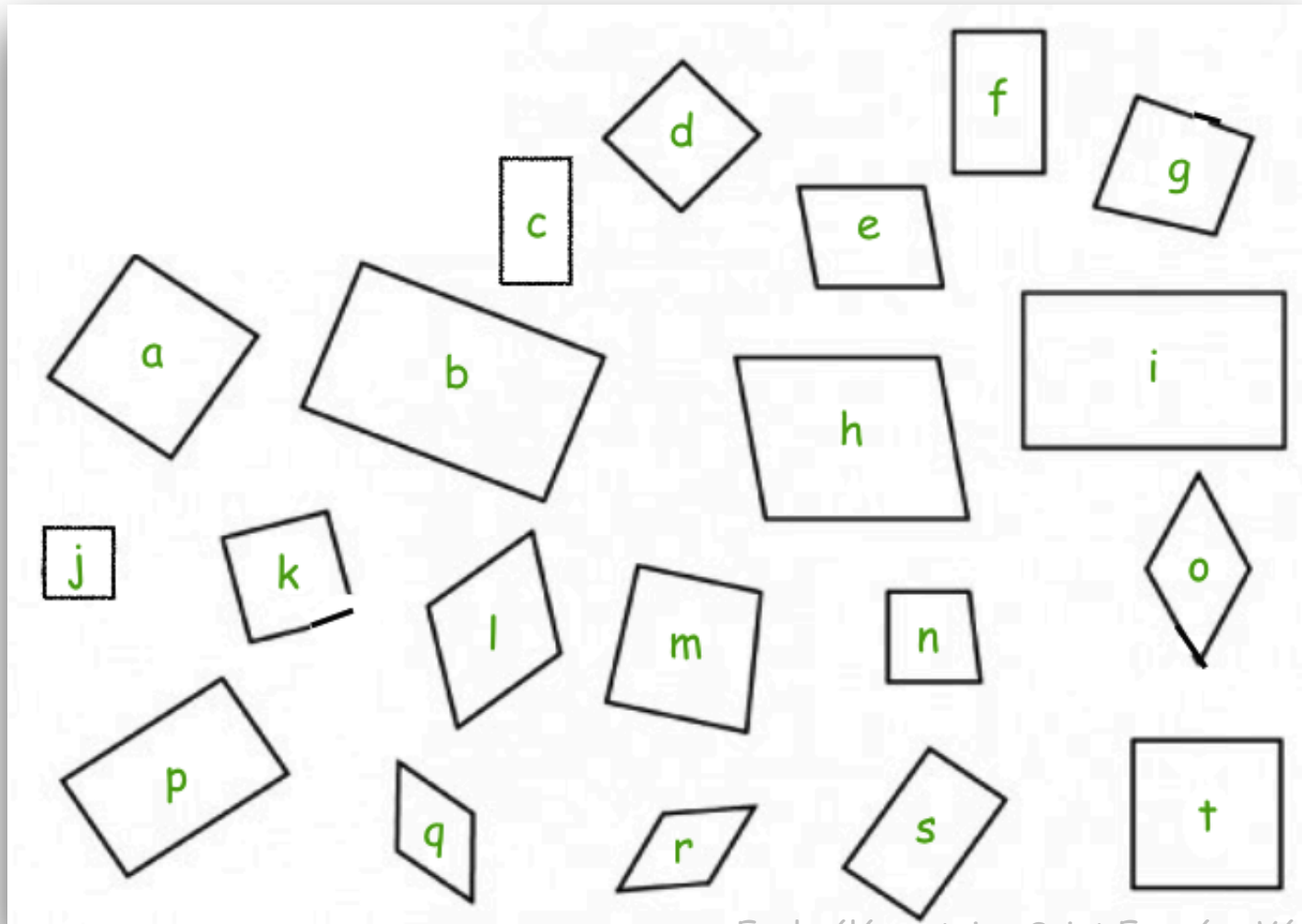

Correction : a d j t

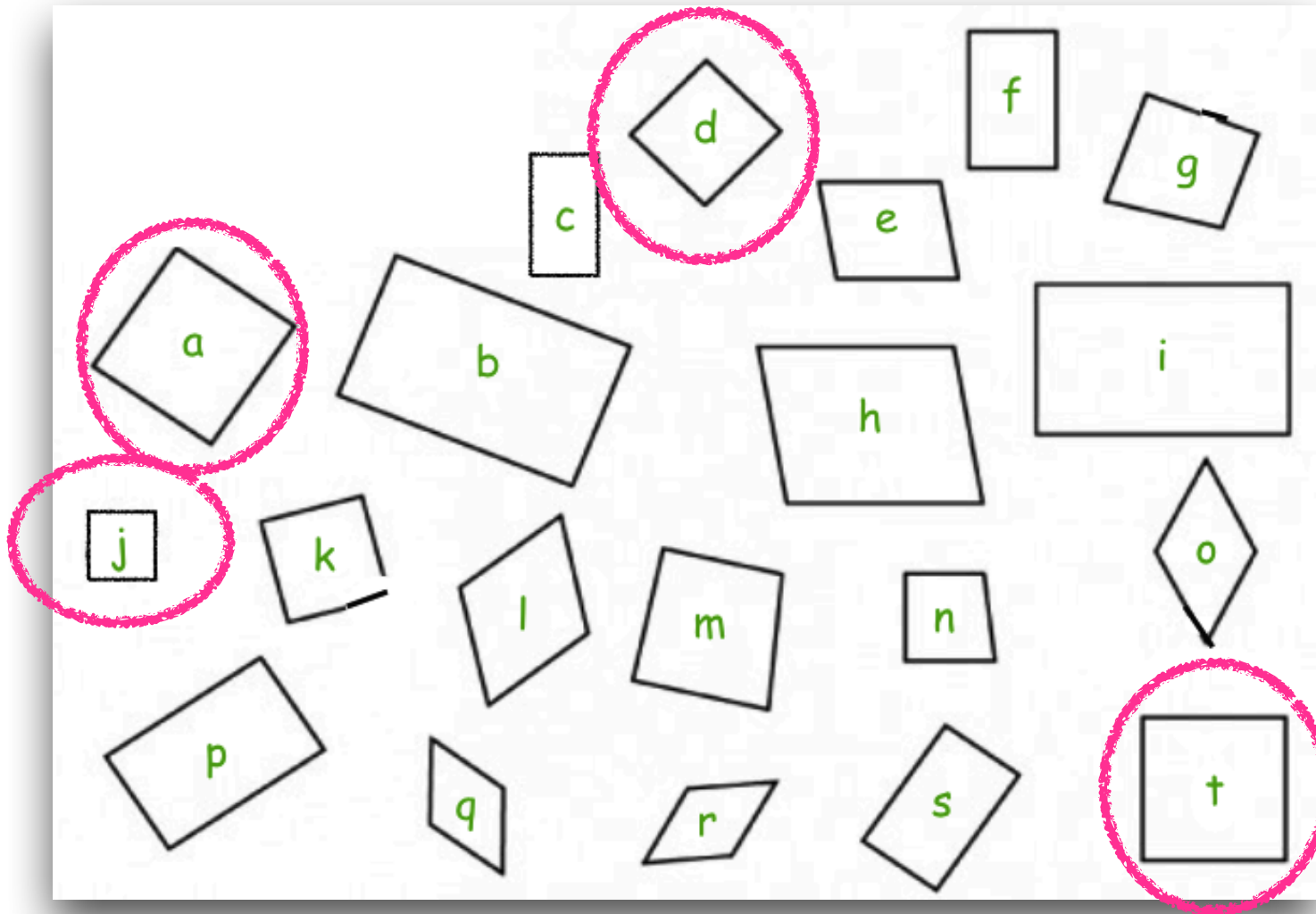

4. Sur ton ardoise, écris quelles figures sont des rectangles.

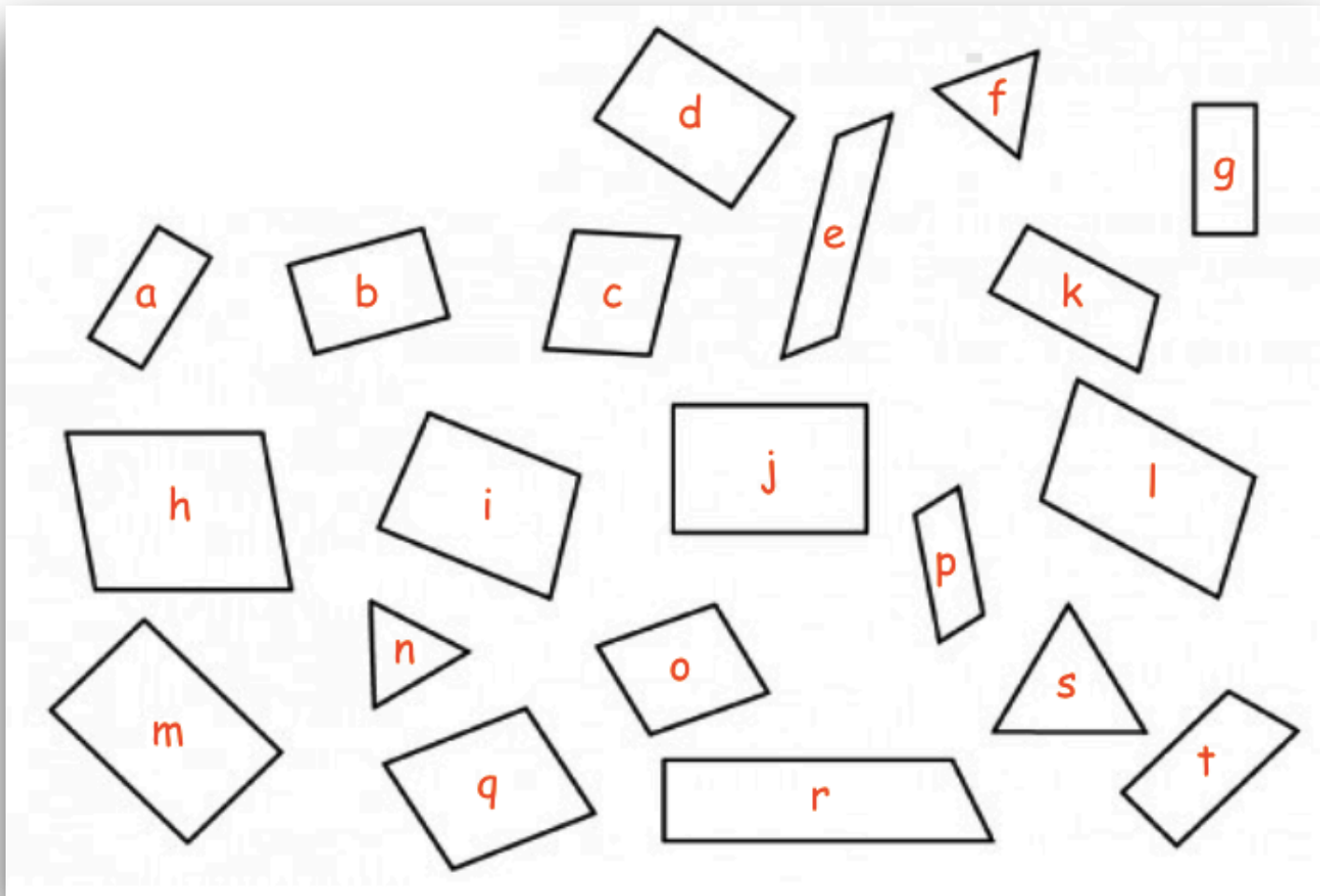

Correction : a b d g j m

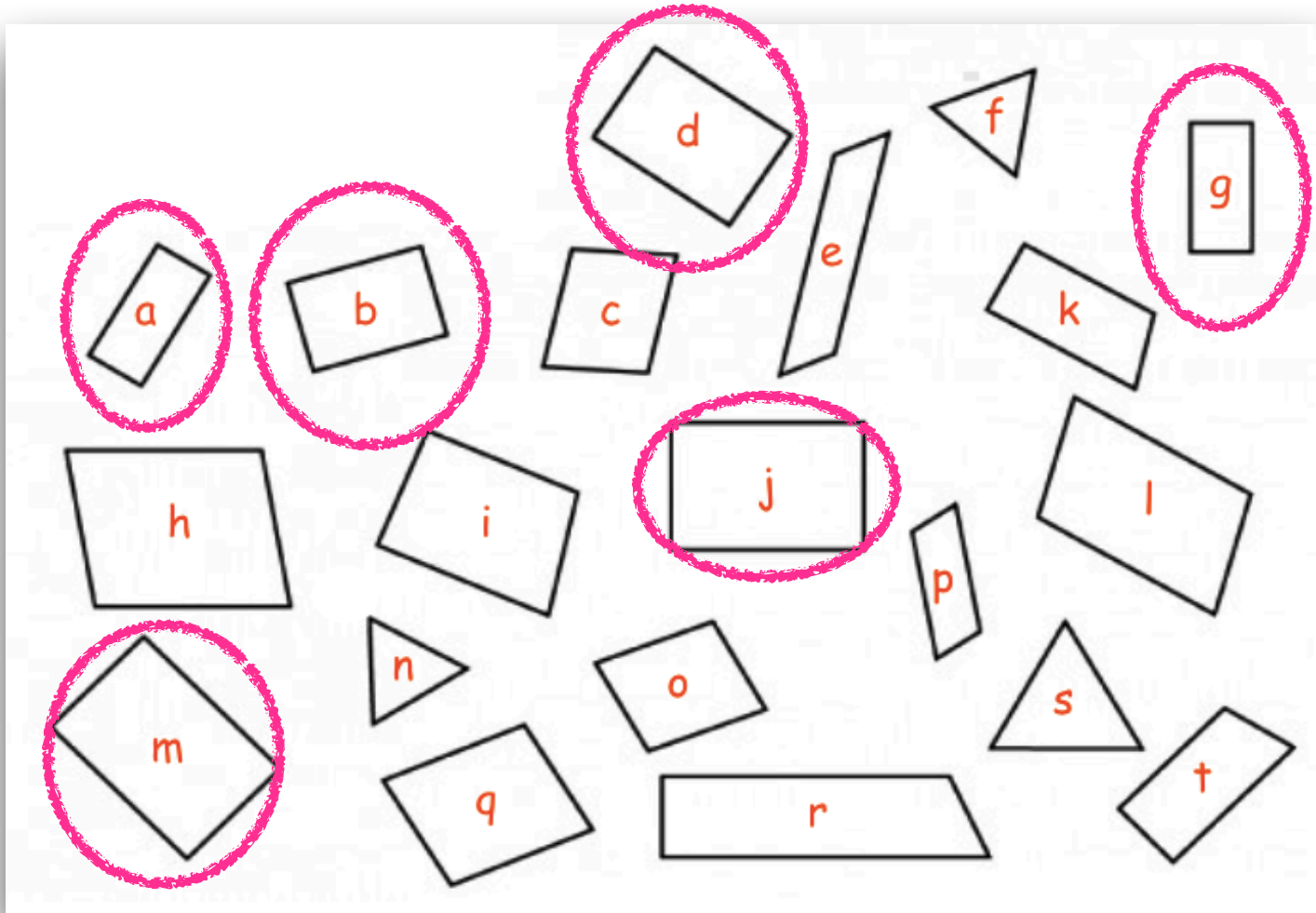



Reconnaitre des solides

1. Lesquelles de ces figures sont des solides?

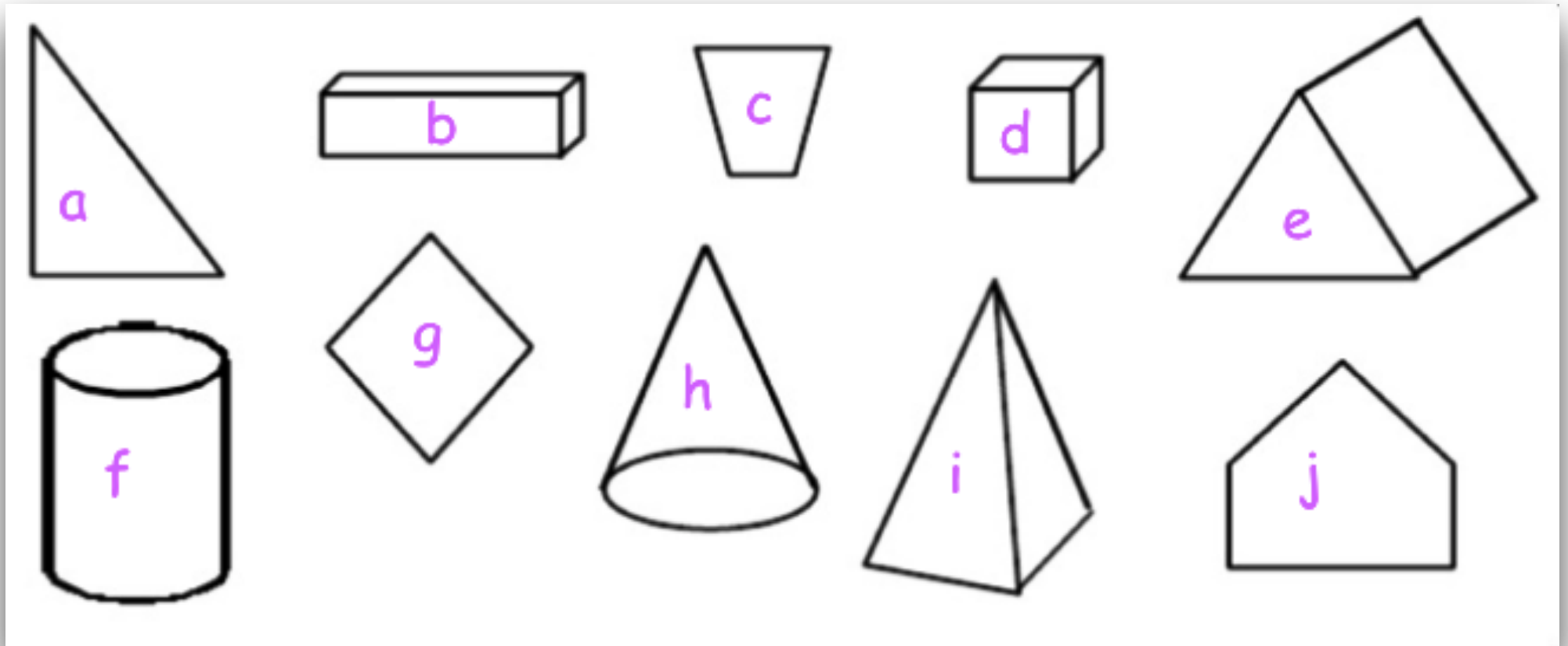

Correction : b d e f h i

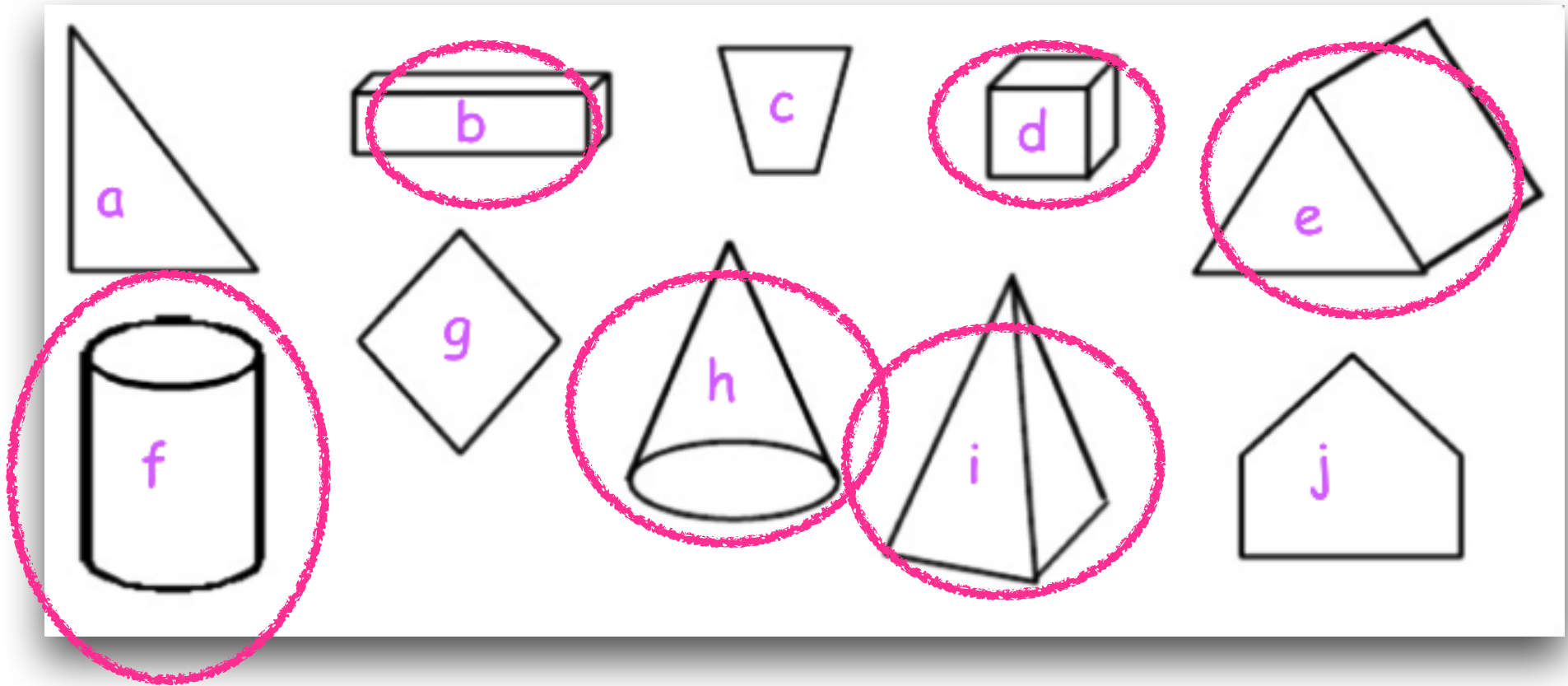

2. Associe chaque solide à son empreinte.

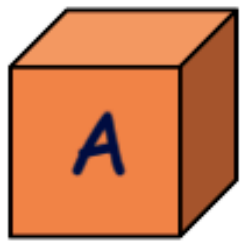

Correction : A2 B1 C3 D4

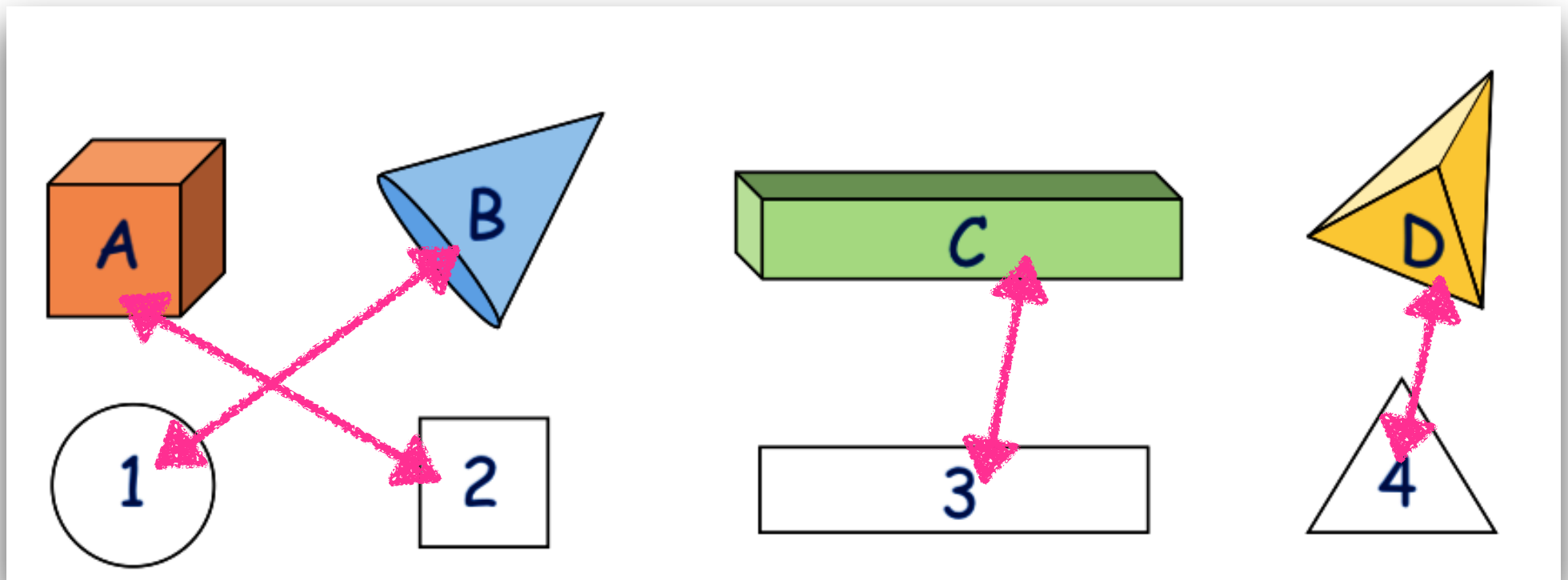

3. Associe chaque solide à un objet de la même forme.

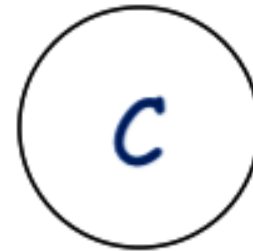
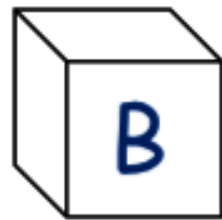
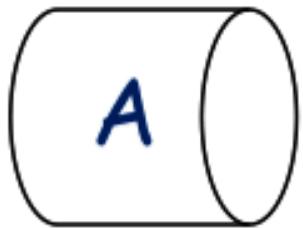

Correction : A2 B1 C4 D3

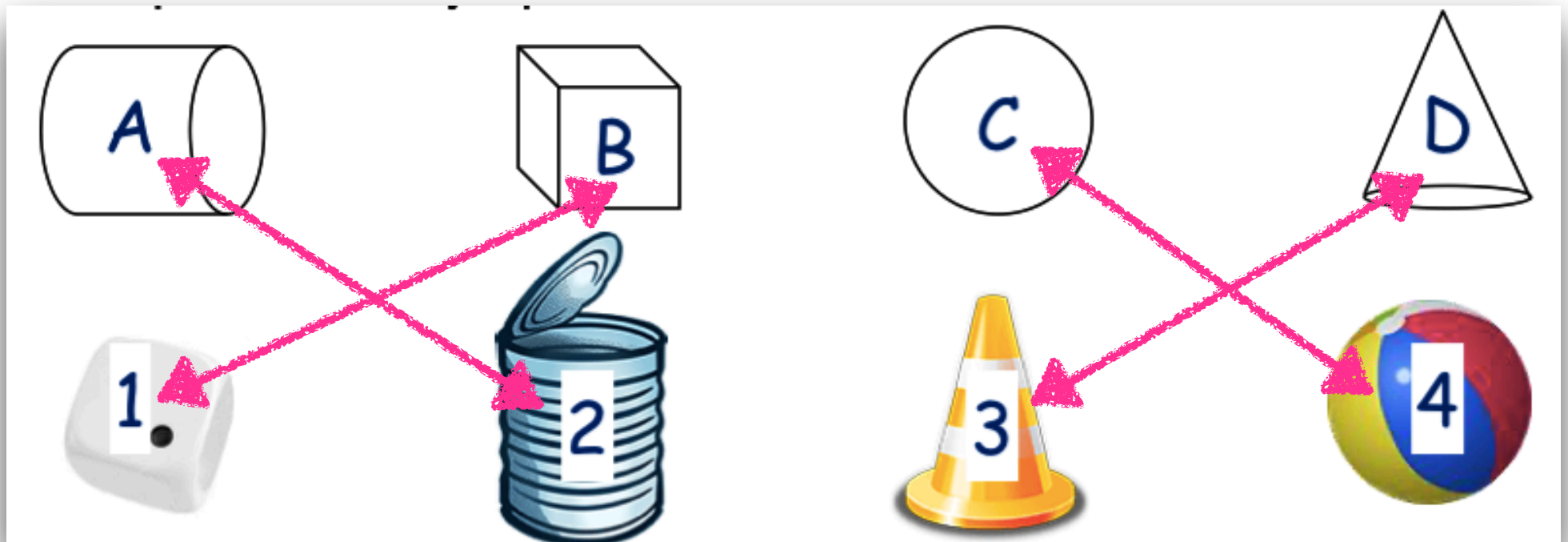

4. Complète :

Le cube possède :

— sommets

— faces

— arêtes

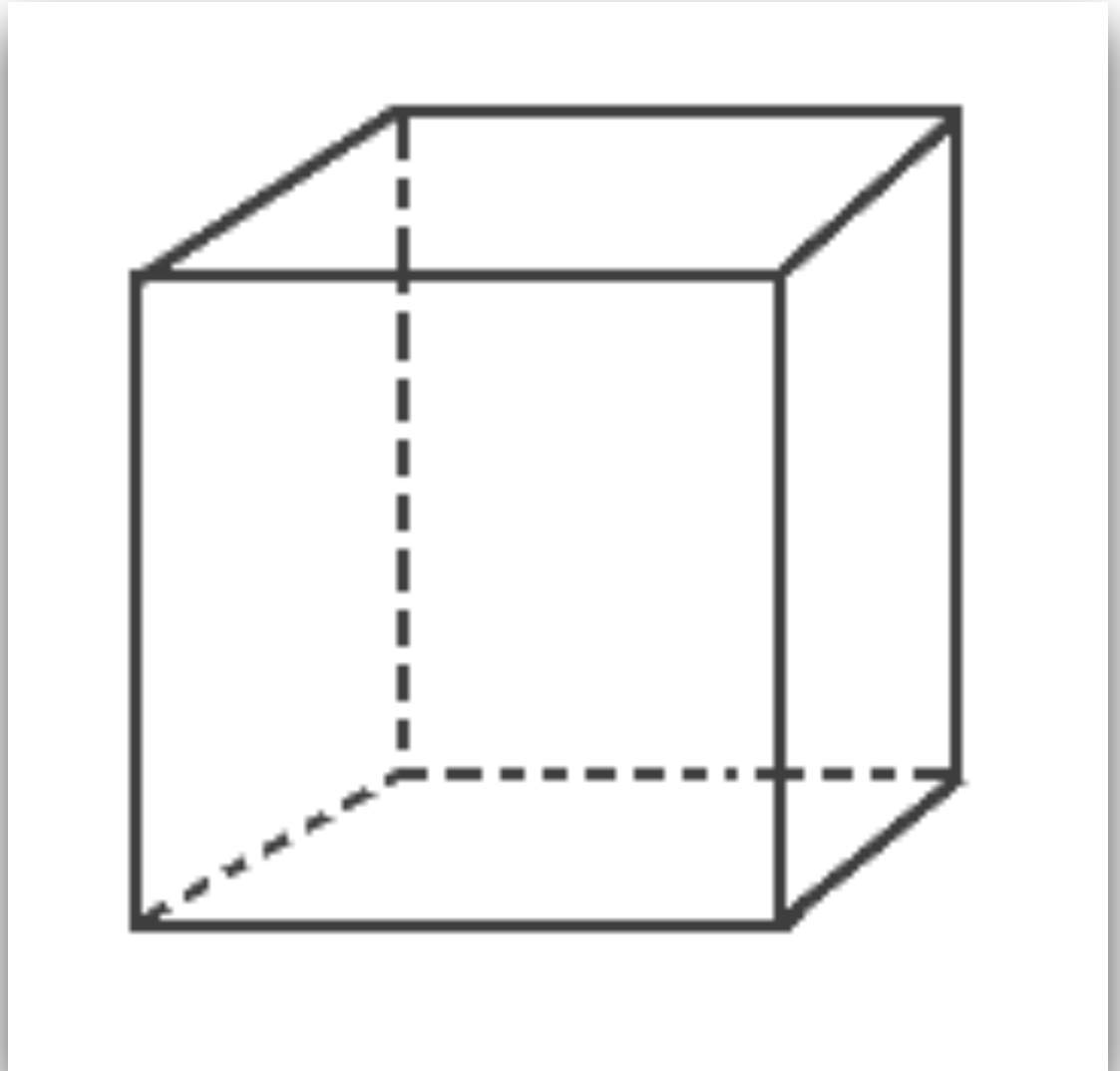

Correction :

Le cube possède :

8 sommets

6 faces

12 arêtes

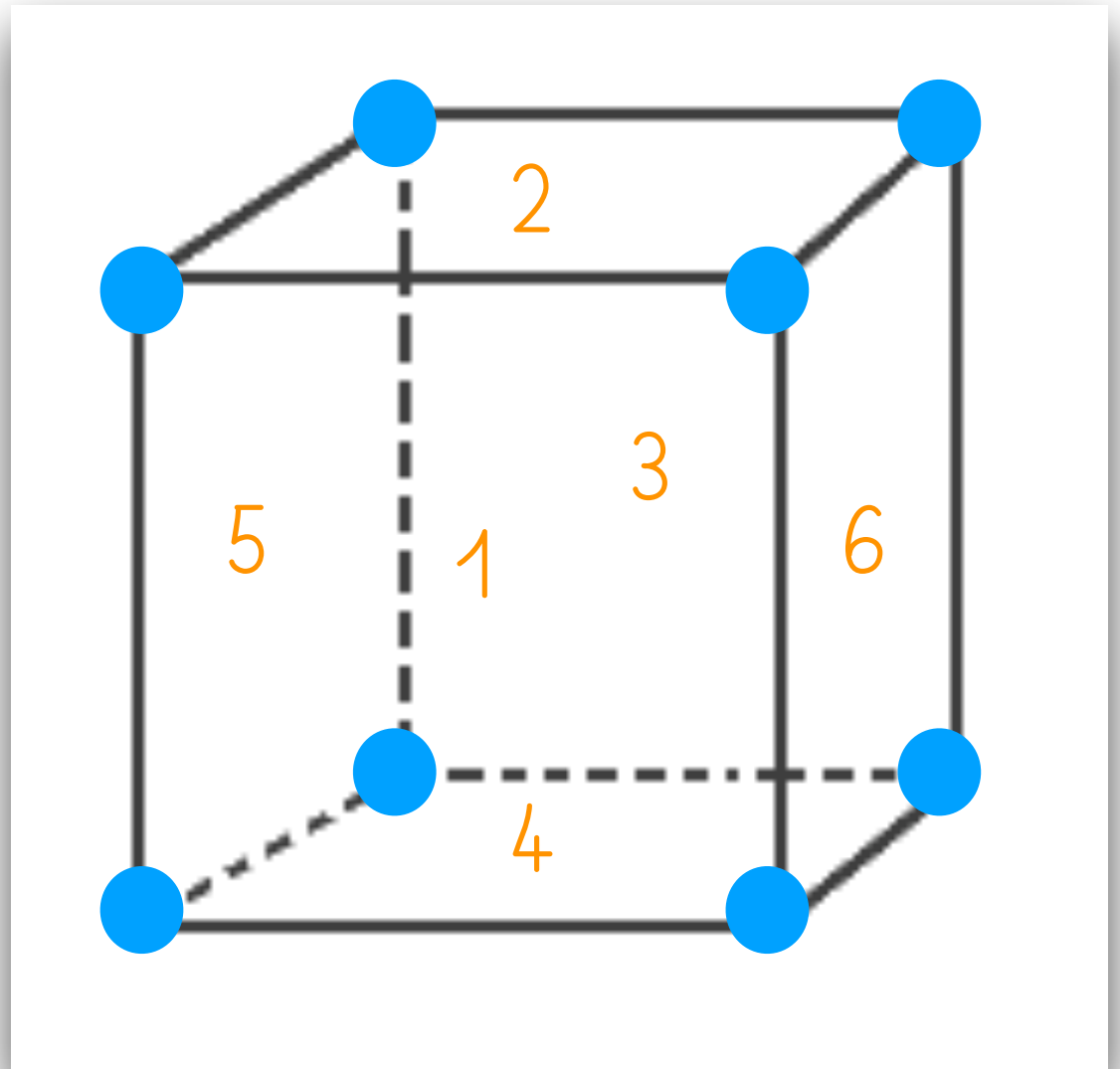

5. Complète :

Le pavé droit possède :

— sommets

— faces

— arêtes

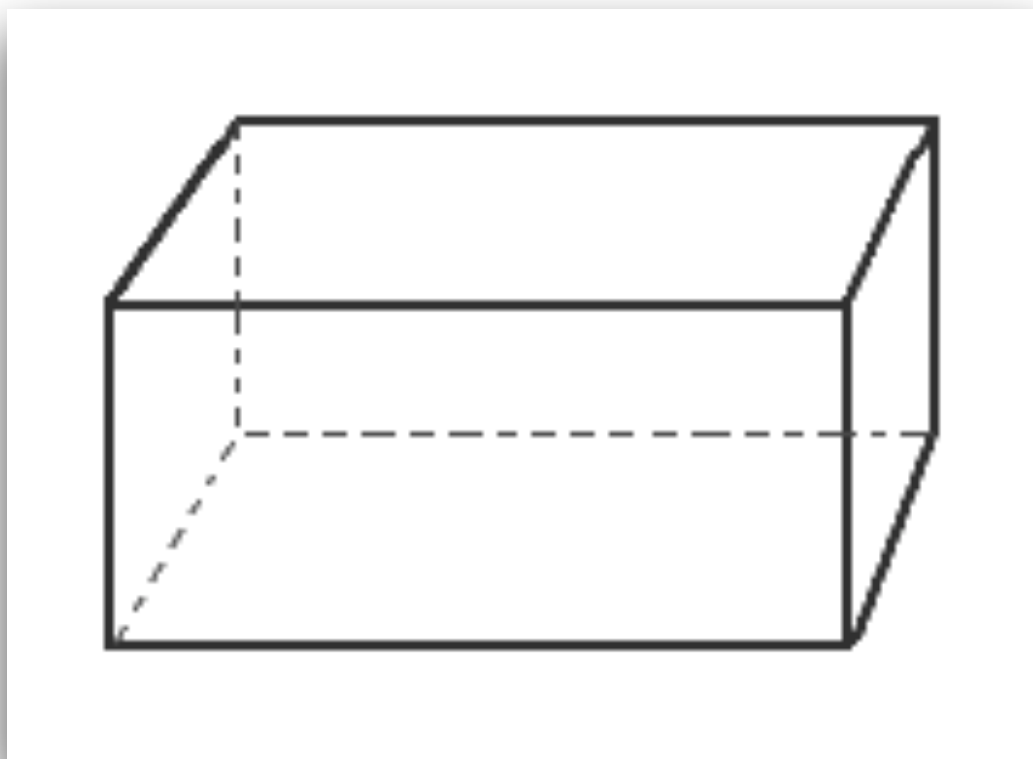

Correction :

Le pavé droit possède :

8 sommets

6 faces

12 arêtes

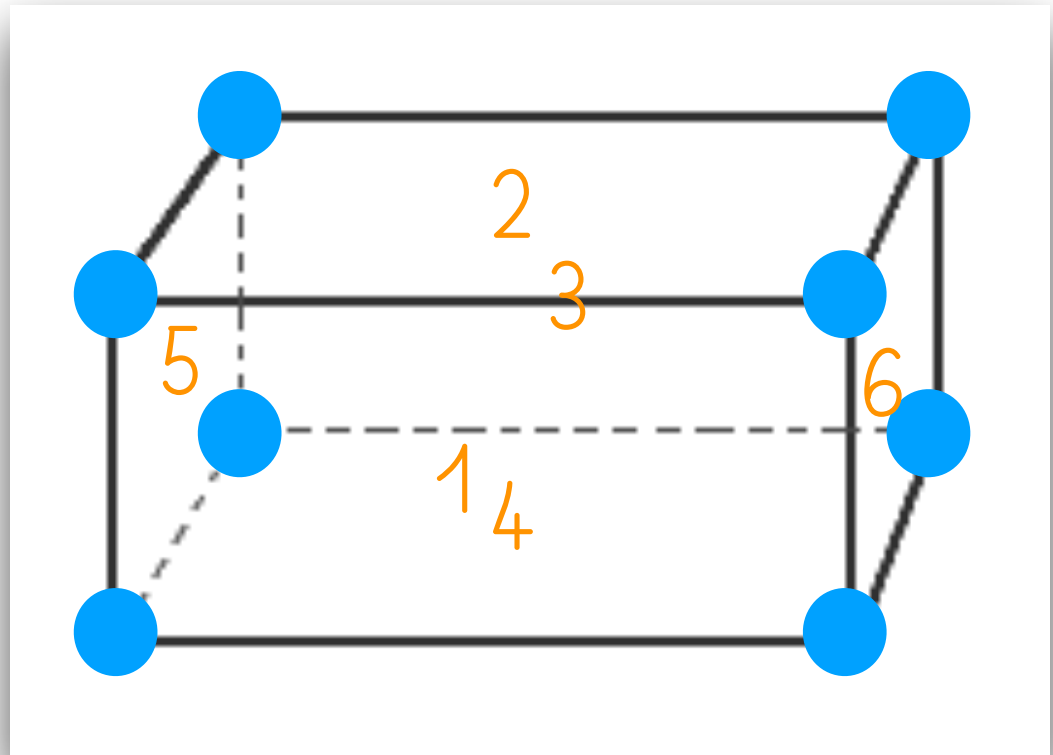

6. Sur ton ardoise, écris quels objets sont des pyramides.



Correction : 1 3 6 7 9



7. Sur ton ardoise, écris quels objets sont des cylindres.



Correction : 1 3 5 7 8



8. Sur ton ardoise, écris quels objets sont des cônes.

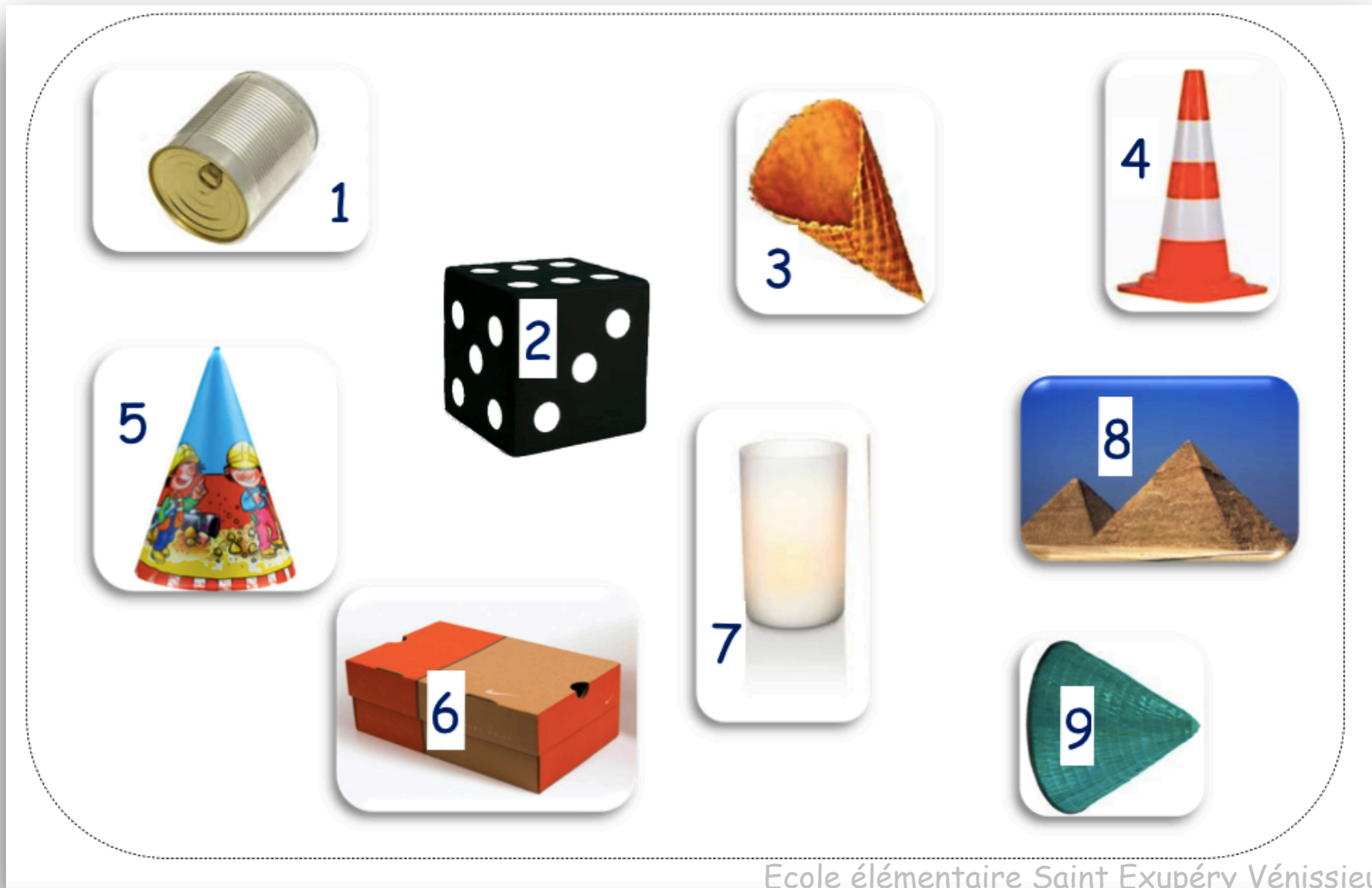

Correction : 3 5 9

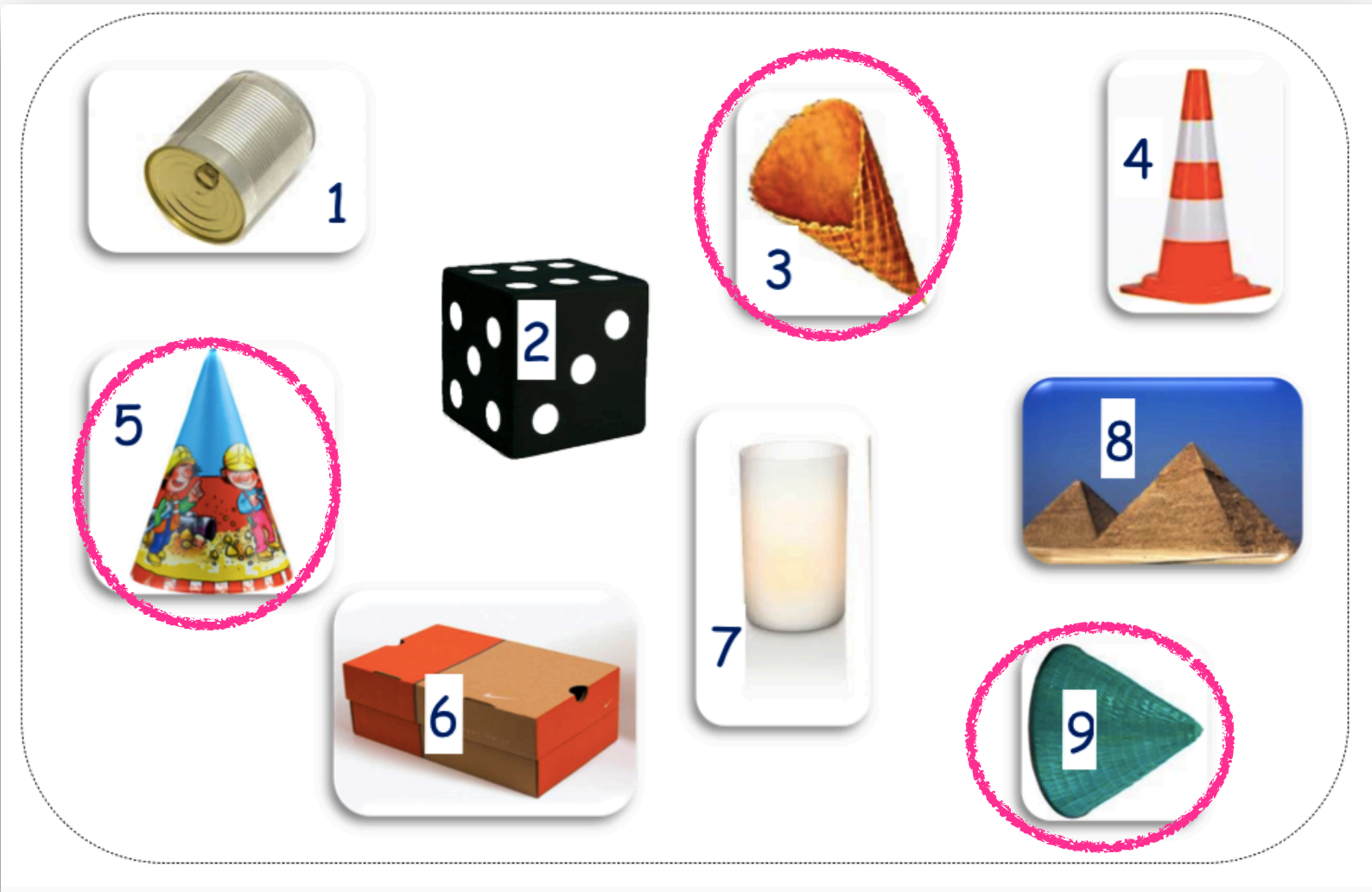



Reproduire des algorithmes

1. Sur ta fiche reproduis et poursuis le
coloriage: (voir annexes)

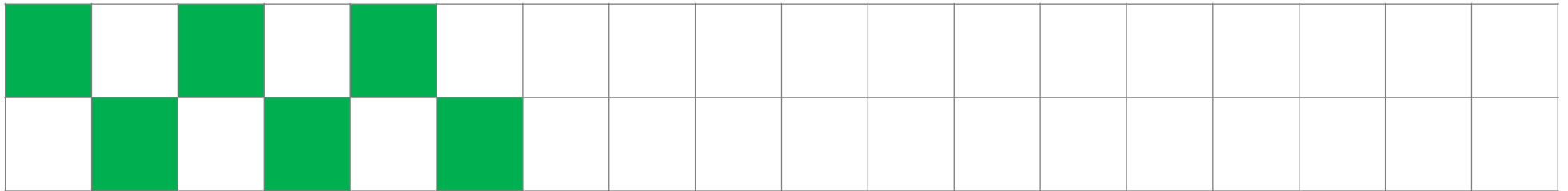

2. Sur ta fiche reproduis et poursuis le coloriage: (voir annexes)

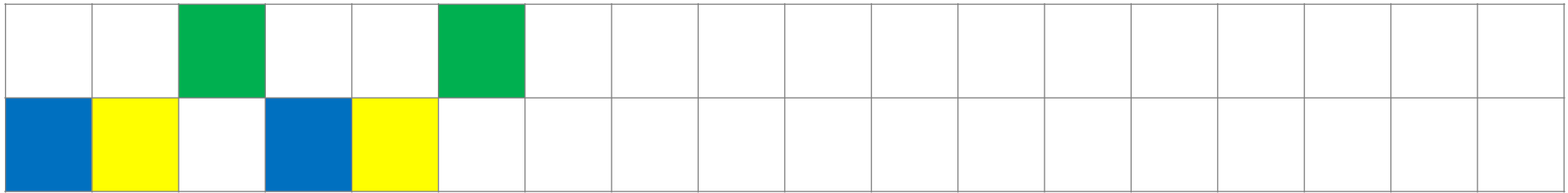

3. Sur ta fiche reproduis et poursuis le coloriage: (voir annexes)

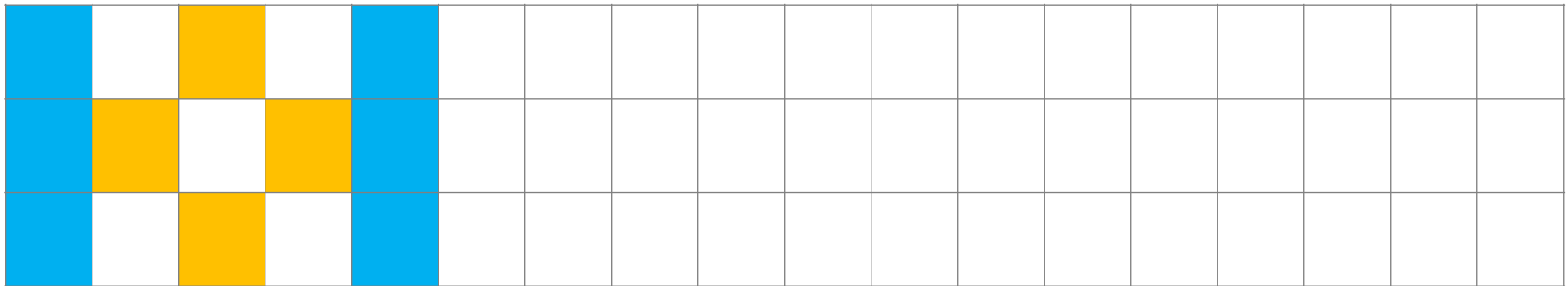

4. Sur ta fiche reproduis et poursuis le coloriage: (voir annexes)

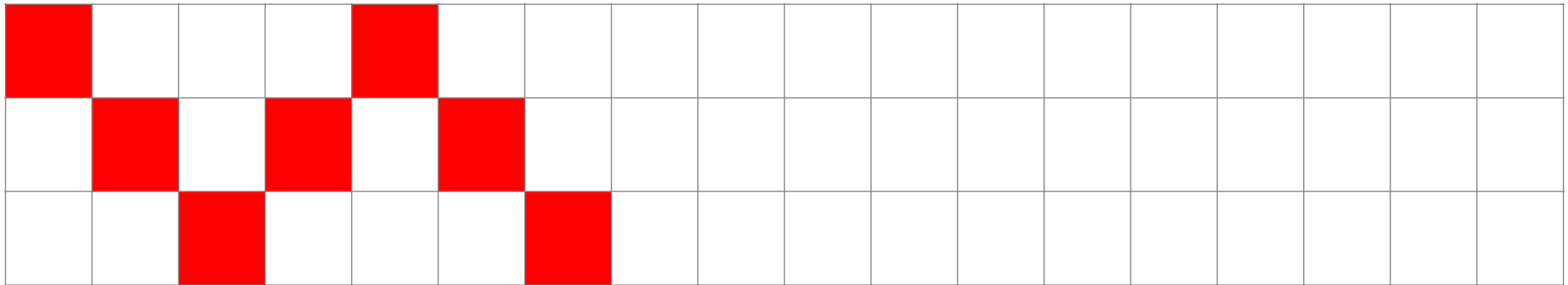

5. Sur ta fiche reproduis et poursuis le coloriage: (voir annexes)

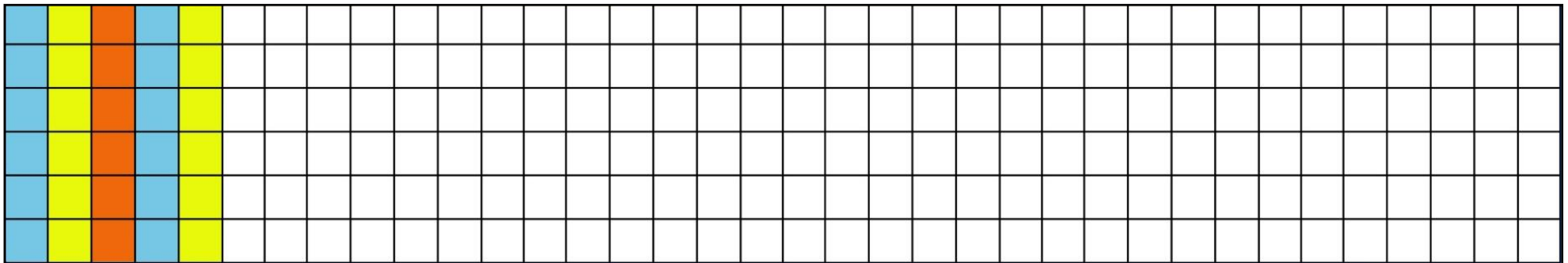

Annexes algorithmes : fiches à distribuer.

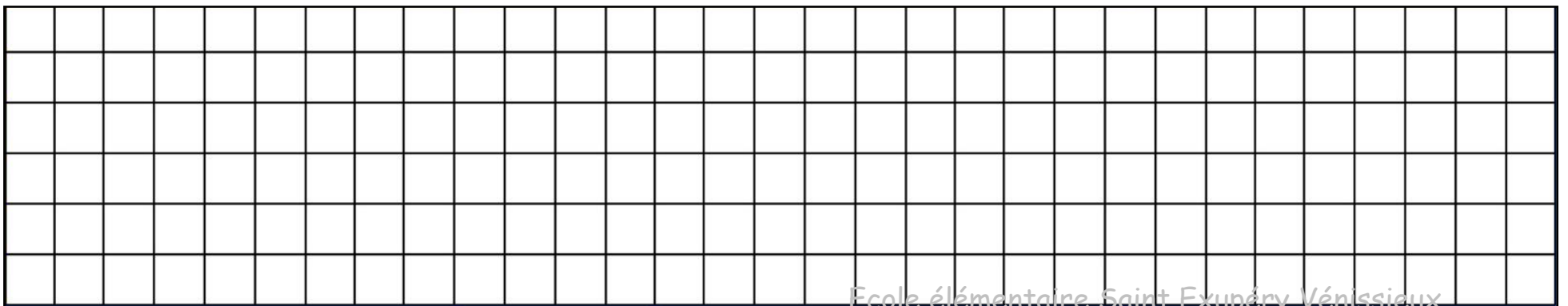
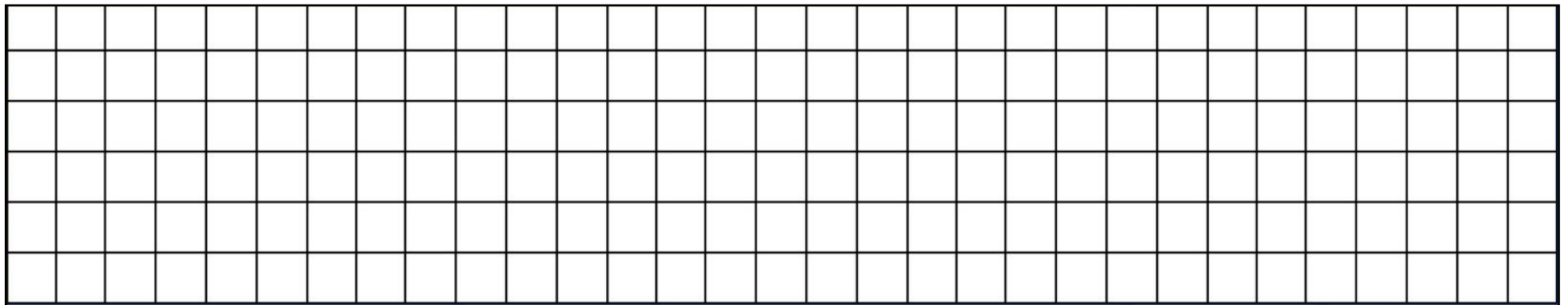
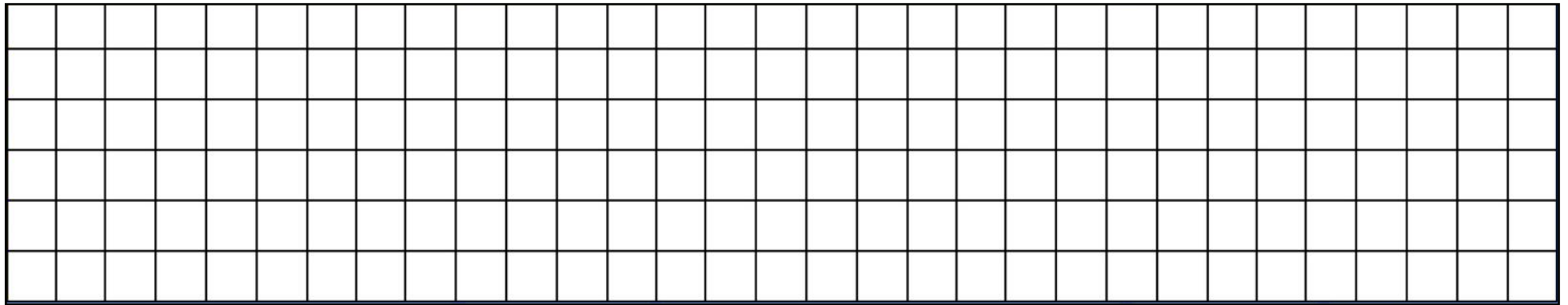

Les ressources

- Bout de gomme
- Les coccinelles
- L'école de crevette
- Charivari à l'école
- Zaubette
- Le blog du chat noir
- Maître Lucas